



## 2 Baker Lux Dynamic

- 2.1 Alarm and Warning messages
- 2.2 Hidden menu parameters

# Features

Safe door docking positions at  
60° - 120° - 180°

**Protek.SAFE™**  
Cool touch oven door  
Cool external surfaces  
Improved energy efficiency

Control: *Manual*

## CONTROL PANEL

Control: *Dynamic*

99 baking programs memory, each  
one made of 3 baking steps + pre-  
heating



# Technical details

**AIR.Plus**

Auto-reversing motors  
combined with high speed  
revolving fans

**High-durability carbon  
fibre door lock**

**STEAM.Plus**

Instant humidity creation inside the baking  
cavity from a temperature of 90 °C

**Baking cavity design**

Built in stainless steel  
Rounded corners  
Easy extraction of the lateral grid supports

**High durability halogen lamp**



**Operable internal glass for  
easy cleaning**

# Technical details

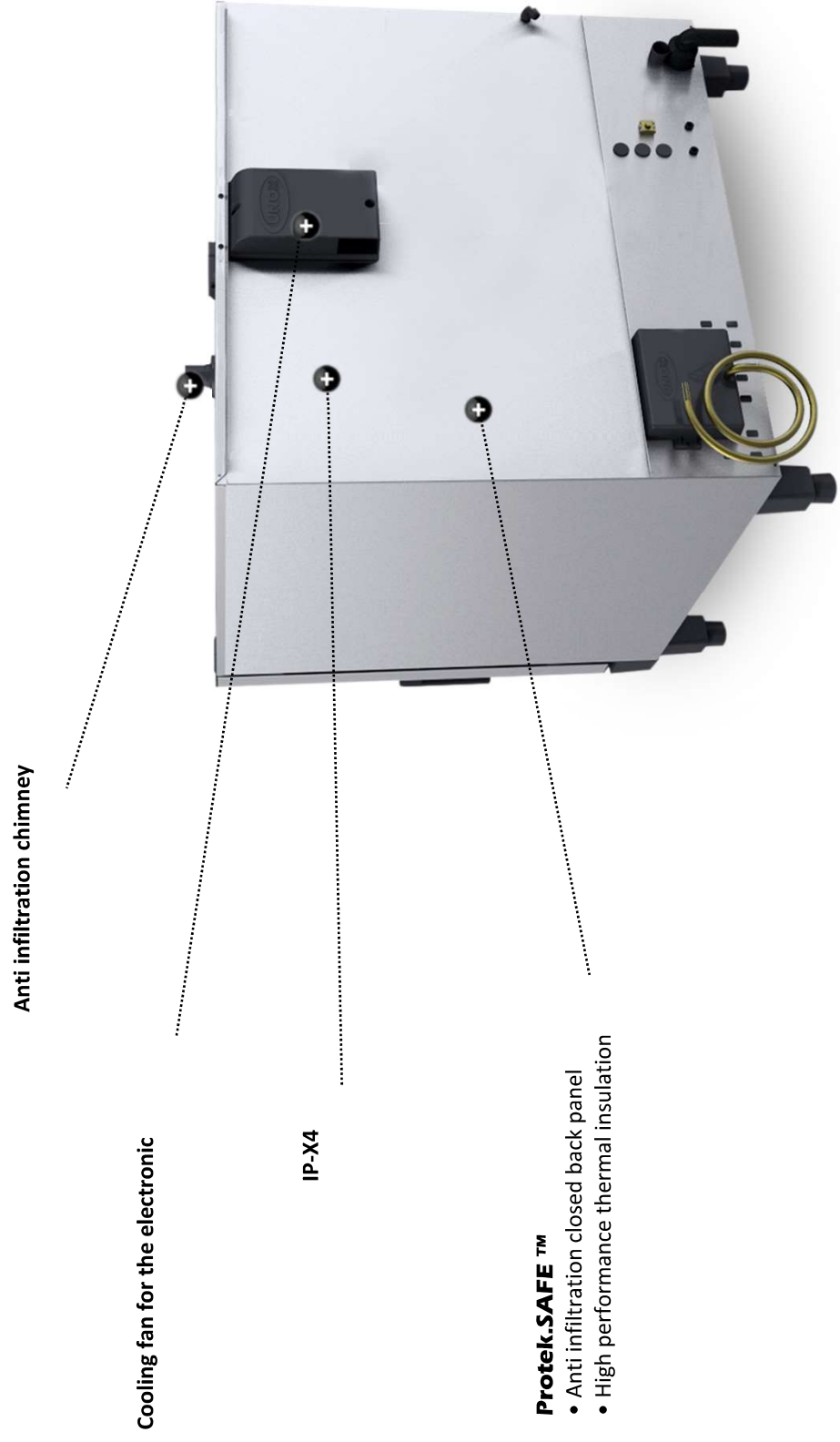

Cooling fan for the electronic

Anti infiltration chimney

IP-X4

**Protek.SAFE™**

- Anti infiltration closed back panel
- High performance thermal insulation

# Control panel

***Dynamic*** and ***Manual***.  
Each control panel is customized and designed for a quick

*Dynamic*

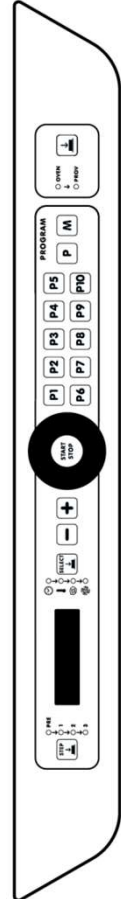

*Manual*



# Control Panel



## *Dynamic* control panel

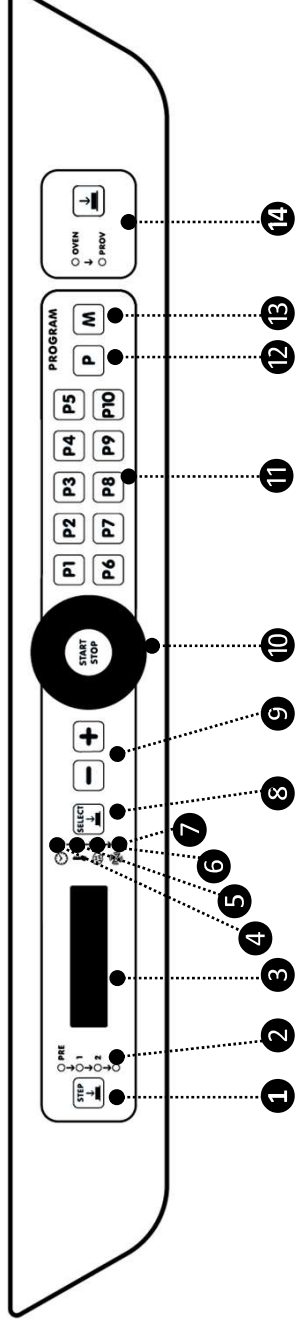

- 1 - Key to select baking step
- 2 - Baking step LED
- 3 - Display to visualize the baking parameters
- 4 - Baking time LED
- 5 - Baking temperature LED
- 6 - Humidity LED
- 7 - Fan LED
- 8 - Time, temperature, humidity and fan speed selection
- 9 - Baking parameters increase / decrease
- 10 - START/STOP baking cycle
- 11 – Direct-access program selection
- 12 - Program menu recall – 99 programs
- 13 - Program memorizing
- 14 - Select oven or proof

## 2.1 Alarm and warning messages

Display	Alarm Description	Effect	Causes	Solutions	Replacing kit
AF01	Motor thermic protection intervention	The oven interrupts any operation in progress	<p>Failure of the back PCB</p> <p>White thermic protection wires of the motor/s without continuity</p> <p>Make sure that the oven is installed following the guideline «oven positioning, section 1.2 and 1.3»</p>	<p>Replace the back PCB</p> <p>Replace the motor/s</p> <p>Install the oven sticking to the instructions</p>	<ul style="list-style-type: none"> <li>• KPE1810B</li> <li>• KVN1130A</li> </ul>



Resistance = 4-5 Ω

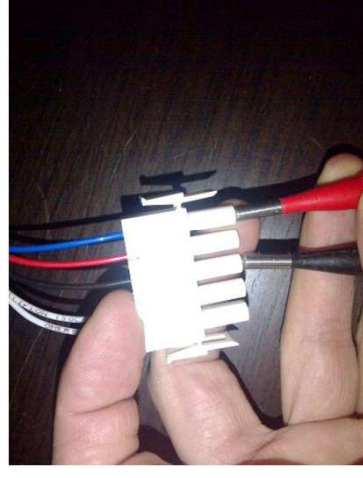

Resistance = 35-55 Ω



## 2.1 Alarm and warning messages

AF02	Safety thermostat alarm	The oven interrupt any operation in progress	Overheating of the cooking chamber (higher than 310°C)	<p>Check the main power supply according to the technical data sheet supplied with the oven or download them from the Infonet section at <a href="http://www.infonet.com">www.infonet.com</a></p> <p>Replace the temperature probe (check the continuity to the two pins as shown below) and reset the Alarm AF02 as per the pictures to the next page</p> <p>Replace the back PCB</p>	<ul style="list-style-type: none"> <li>• KTR1105A</li> <li>• KPE1810B</li> </ul>
------	-------------------------	--	--	--	--





## 2.1 Alarm and warning messages



1

In case of replacement of the temperature probe connected to the oven PCB socket P22, the alarm AF02 remains visualized until the reset operation is done.

- **Hold** the white safety thermostat reset **button** to the right interface board for precisely 6 seconds then release
- Press the «P» button once to the display to definitively erase the AF02 alarm from the main memory of the oven

2

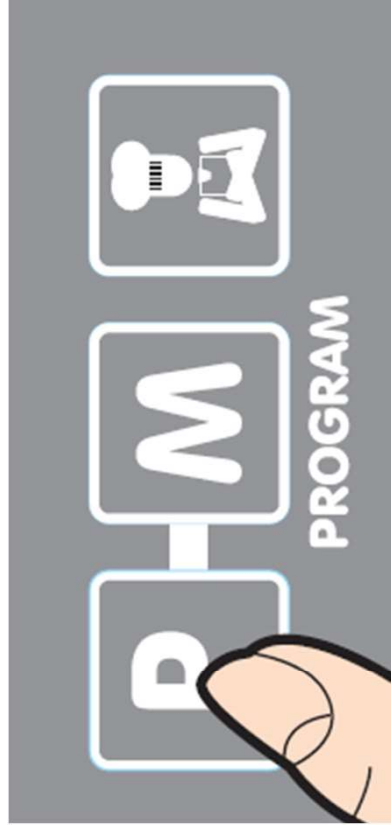

## 2.1 Alarm and warning messages











AF03	Temperature probe failure	The oven interrupts any operation in progress	<ul style="list-style-type: none"> <li>• The temperature probe has failed</li> <li>• Back PCB failure</li> </ul>	<ul style="list-style-type: none"> <li>• Replace both temperature probes</li> <li>• Replace the back PCB</li> </ul>	<ul style="list-style-type: none"> <li>• KTR1105A</li> <li>• KPE1810B</li> </ul>
AF04	Loss of communication	The oven interrupts any operation in progress	<ul style="list-style-type: none"> <li>• Connection failure with the accessories (check the data cable connection)</li> <li>• Check the display panel – back PCB data connection cable</li> </ul>	<ul style="list-style-type: none"> <li>• Check the data cable connection with the accessories</li> <li>• Check the display panel – control panel connection as shown below</li> </ul>	<ul style="list-style-type: none"> <li>• Data cable replacement</li> <li>• Display panel / power board data cable replacement</li> </ul>



## 2.1 Alarm and warning messages

<p>UF01 Back cooling fan Warning</p>	<p>The oven continues the operation in progress but the cooling of the main oven's components will not be ensured</p>	<ul style="list-style-type: none"> <li>• Cooling fan wire disconnected from the oven PCB</li> <li>• Damaged cooling fan</li> <li>• Damaged oven PCB</li> </ul>	<ul style="list-style-type: none"> <li>• Connect the cooling fan wire to the oven PCB to the socket P23</li> <li>• Replace the cooling fan</li> <li>• Replace the oven PCB</li> </ul>	<ul style="list-style-type: none"> <li>• KVN1120B</li> <li>• KPE1725D</li> </ul>
<p>UF02 Oven PCB Temperature Warning</p>	<p>The temperature of the PCB exceeds 70°C, the oven will continue the operations in progress</p>	<ul style="list-style-type: none"> <li>• Oven not correctly positioned in the kitchen</li> <li>• Back cooling fan doesn't work</li> <li>• Damaged oven PCB</li> </ul>	<ul style="list-style-type: none"> <li>• Refer to the «positioning» step at the installation slides</li> <li>• Replace the cooling fan</li> <li>• Replace the oven PCB</li> </ul>	<ul style="list-style-type: none"> <li>• KVN1120B</li> <li>• KPE1810B</li> </ul>

## 2.2 Hidden menu parameters

- Press  and  together for 5 seconds
- Press  to choose the net addresses. As for the Chef Top and Baker Top ovens the NET addresses are
  - 1 Power board
  - 10 Display board
- Press  to enter into the single board setup
- Press  and  to recall the parameter to adjust
- Press  again to enter the parameter setting
- Press  and  to change the parameter value
- Hold the  button for at least 5 seconds at the end of each modification to save the setting
- Press  two times to exit from each hidden menu

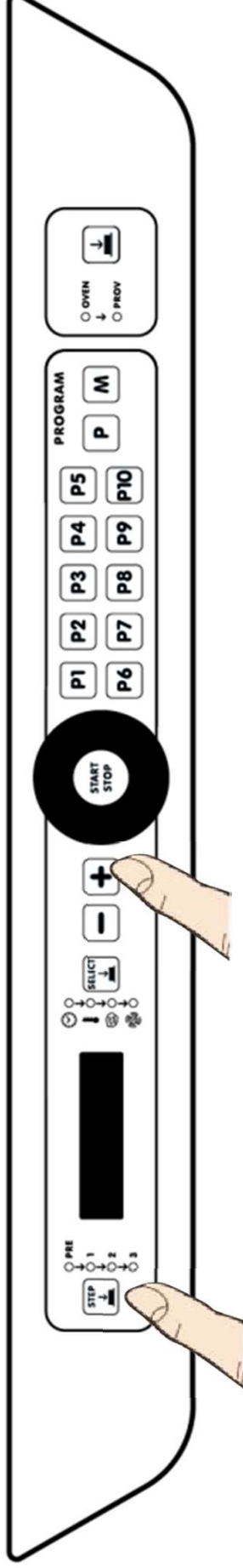

## 2.2 Hidden menu parameters

### 10 – Display board hidden menu

Board code	Parameter name	Description
PE1985A0	FRW	Firmware
PE1985A0	CD1	Display board code
PE1985A0	CD2	Display board version
PE1985A0	NET	Net address
PE1985A0	OV	Master & Slave - Not used
PE1985A0	SNB	Board serial number
PE1985A0	TDB	Assembly line test date
PE1985A0	TTB	Assembly line test time
PE1985A0	DEG	Celsius or Fahrenheit
PE1985A0	STB	Stand-by activation
PE1985A0	LMP	Lamp activation
PE1985A0	LOC	Lock of first 20 programs (1-20)
PE1985A0	PRG	Manual setting activation
PE1985A0	GN	Not used
PE1985A0	BUZ	Extra buzzer (optional) activation
PE1985A0	STE	Not used
PE1985A0	FOB	Buzzer frequency (not used)
PE1985A0	LAT	Automatic door closure (not used)
PE1985A0	SEN	Touch buttons sensitivity (standard = 8)
PE1985A0	RIC	Touch buttons calibration (standard = 2)

## 2.2 Hidden menu parameters

### 1 – Power board hidden menu

Board code	Parameter name	Description
PE1810B0	FRW	Firmware
PE1810B0	CD1	Power board code
PE1810B0	CD2	Power board version
PE1810B0	NET	Net address
PE1810B0	SNB	Serial Number board
PE1810B0	TDB	Power board test date
PE1810B0	TTB	Power board test time
PE1810B0	SND	Oven serial number
PE1810B0	TDD	Assembly line test date
PE1810B0	TTD	Assembly line test time
PE1810B0	MAS	Maximum setpoint temperature
PE1810B0	RES	Heating element activation
PE1810B0	HRD	Working hour alarm (not used)
PE1810B0	TMD	Maximum temperature reached from the power board
PE1810B0	DF1	Isteresis regulation of the temperature probe
PE1810B0	OF1	Offset regulation temperature probe
PE1810B0	MOD	Oven model (not used)
PE1810B0	NM	Number of motors (not used)
PE1810B0	TFN	Cooling fan temperature activation
PE1810B0	DFN	Isteresis cooling fan temperature
PE1810B0	SSR	Not used



## **3** Line Miss Touch

- 3.1 Alarm and Warning messages
- 3.2 Hidden menu parameters
- 3.3 Upgrading procedure

## Features

**Lighting with a long life halogen lamp**

**AIR.Plus**  
Auto-reversing motor fan (not available in the Manual Humidity models 460x330)  
High speed fans

**Advanced log-lasting gasket technology**

**Hygiene in the chamber**

- Built in stainless steel with rounded corners
- Easy extraction of the lateral grid supports

**Hinges, designed and tested for more 100,000 openings, Always with perfectly balanced**

**Door switch**  
(not available in the Manual Humidity models 460x330)

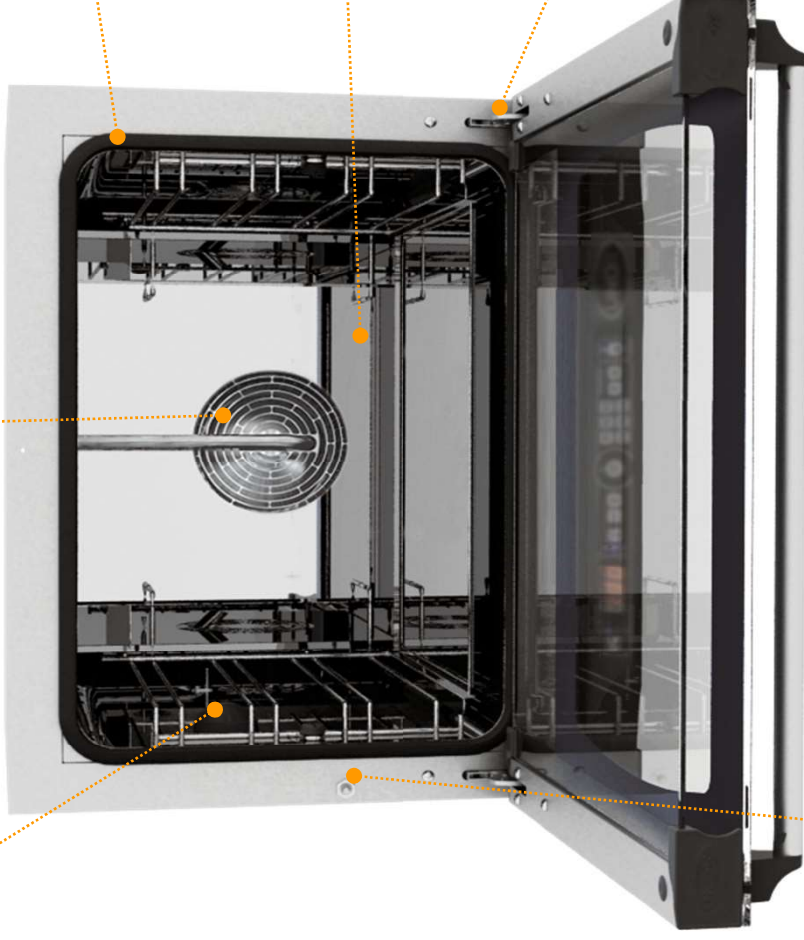



## Features

# TouchControl

*Dynamic*



*Matic*



*Classic*



Display board PE1980A0

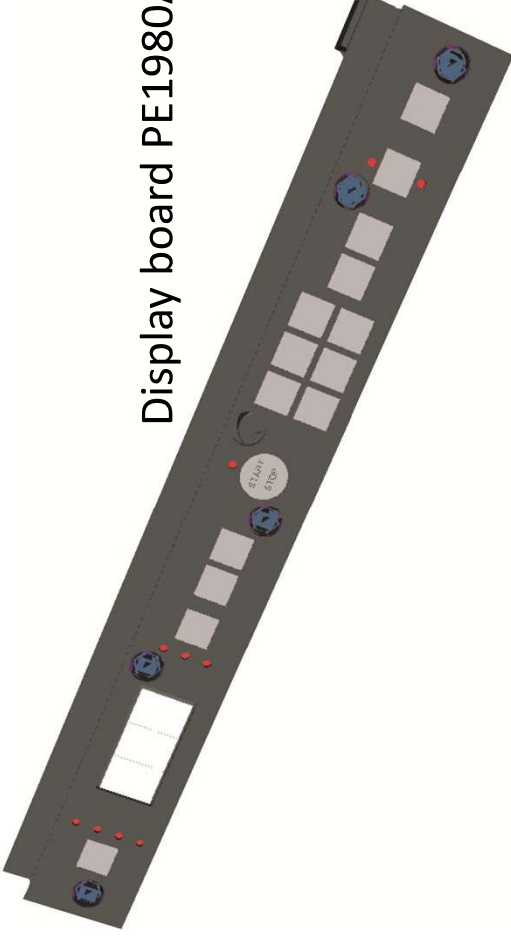

*Matic*

*Dynamic*

*Classic*

**!**Same display board for all version (but different rear power board)

---



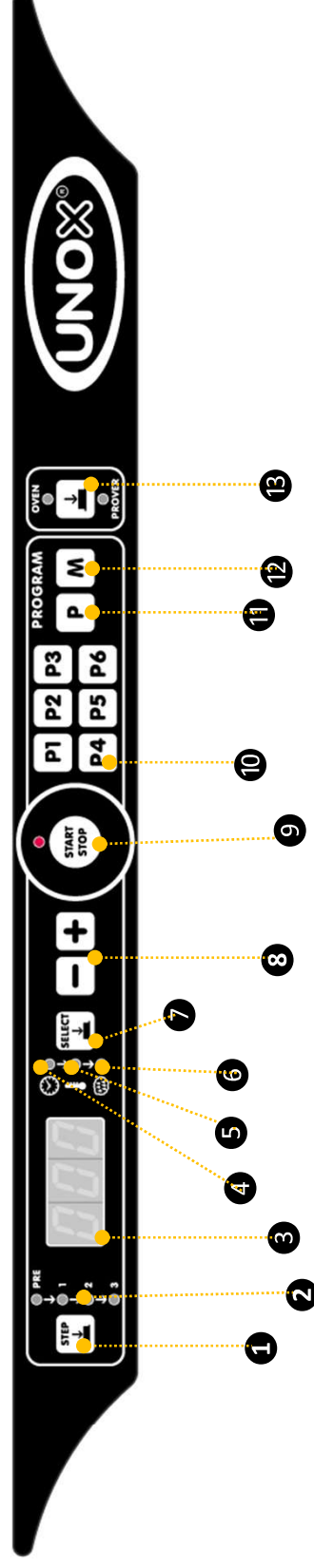

- 1 - Key to select baking step
- 2 - Baking step LED
- 3 - Display to visualize the baking parameters
- 4 - Baking time LED
- 5 - Baking temperature LED
- 6 - Humidity LED
- 7 - Time, temperature, humidity select key
- 8 - Baking parameters increase / decrease key
- 9 - START/STOP baking cycle
- 10 - Quick access to memorized programs
- 11 - Program menu recall key
- 12 - Program memorization key
- 13 - Key to select oven, prover

 New Integrated Function



# Matic

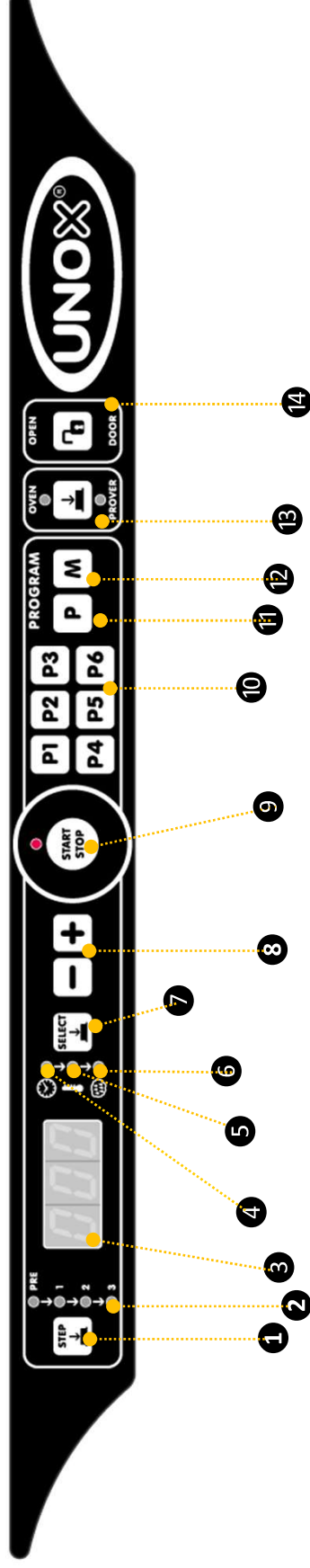

- 1 - Key to select baking step
- 2 - Baking step LED
- 3 - Display to visualize the baking parameters
- 4 - Baking time LED
- 5 - Baking temperature LED
- 6 - Humidity LED
- 7 - Time, temperature, humidity select key
- 8 - Baking parameters increase / decrease key
- 9 - START/STOP baking cycle
- 10 - Quick access to memorized programs
- 11 - Program menu recall key
- 12 - Program memorization key
- 13 - Key to select oven, prover
- 14 - Automatic opening door

**■ New Integrated Function**

# Classic

# LineMiss™

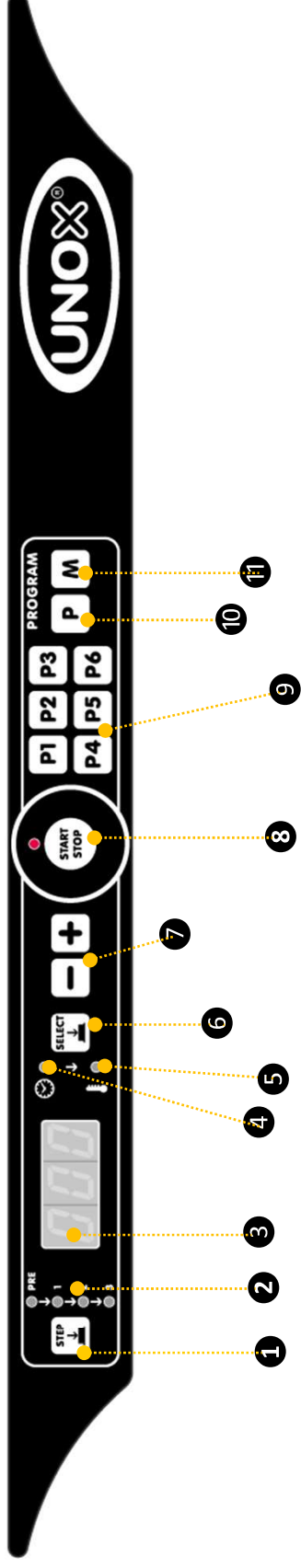

1 - Key to select baking step

2 - Baking step LED

3 - Display to visualize the baking parameters

4 - Baking time LED

5 - Baking temperature LED

6 – Time and temperature select key

7 - Baking parameters increase / decrease key

8 - START/STOP baking cycle

9 - Quick access to memorized programs

10 - Program menu recall key

11 - Program memorization key

**New Integrated Function**

### 3.1 Alarm and warning messages

Display	Alarm Description	Effect	Causes	Solutions	Replacing kit
A01	Motor thermic protection intervention	The oven interrupts any operation in progress	<ul style="list-style-type: none"> <li>• Failure of the back PCB</li> <li>• White thermic protection wires of the motor/s without continuity</li> <li>• Make sure that the oven is installed following the guideline «oven positioning, section 1.2 and 1.3»</li> </ul>	<ul style="list-style-type: none"> <li>• Replace the back PCB</li> <li>• Replace the motor/s</li> <li>• Install the oven sticking to the instructions</li> </ul>	KPE1983A(Dynamic-Matic), KPE1964A (Classic)  KVN1130A



Resistance= 4-5 Ω



Resistance= 35-55 Ω

### 3.1 Alarm and warning messages

A02	Safety thermostat alarm	The oven interrupts any operation in progress	Overheating of the cooking chamber (higher than 310°C)	<ul style="list-style-type: none"> <li>Verify the electric continuity between in and out contacts of the safety thermostat, without plugged power supply cord. In case of contact's disconnection, switch the safety thermostat as shown below. If the contacts wouldn't conduct the signal, even after switching the lower button, replace the safety switch.</li> </ul>	<ul style="list-style-type: none"> <li>KTR1134A</li> </ul>
-----	-------------------------	---	--	---	--

Single phase unit – Safety thermostat

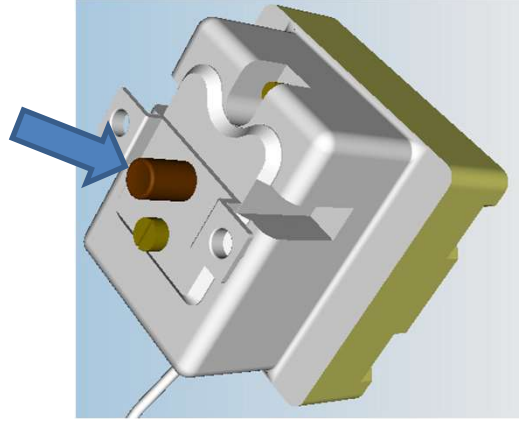

Three phase unit – Safety thermostat

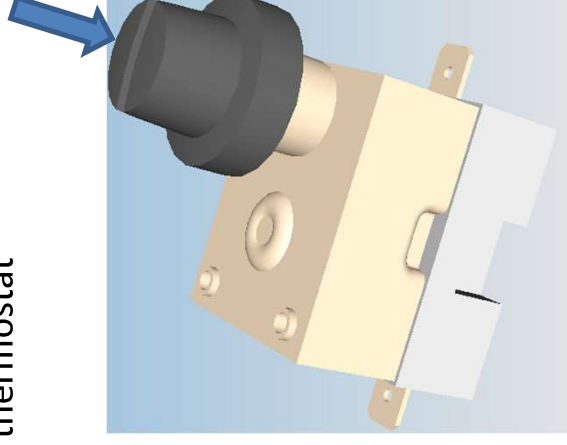

### 3.1 Alarm and warning messages

A03	Temperature probes failure	The oven interrupts any operation in progress	<ul style="list-style-type: none"> <li>Both temperature probes has failed</li> <li>Back PCB failure</li> </ul>	<ul style="list-style-type: none"> <li>Replace both temperature probes</li> <li>Replace the back PCB</li> </ul>	<ul style="list-style-type: none"> <li>KTR1105A</li> <li>KPE1983A (Dynamic-Matic), KPE2010A (Classic)</li> </ul>
A04	Loss of communication	The oven interrupts any operation in progress	<ul style="list-style-type: none"> <li>Connection failure with accessories</li> <li>Damaged power board socket</li> </ul>	<ul style="list-style-type: none"> <li>Check the data cable connection with the accessories</li> <li>Change RJ45 socket connection or replace the rear power board</li> </ul>	<ul style="list-style-type: none"> <li>Data cable replacement</li> <li>KPE1983A (Dynamic-Matic), KPE2010A (Classic)</li> </ul>

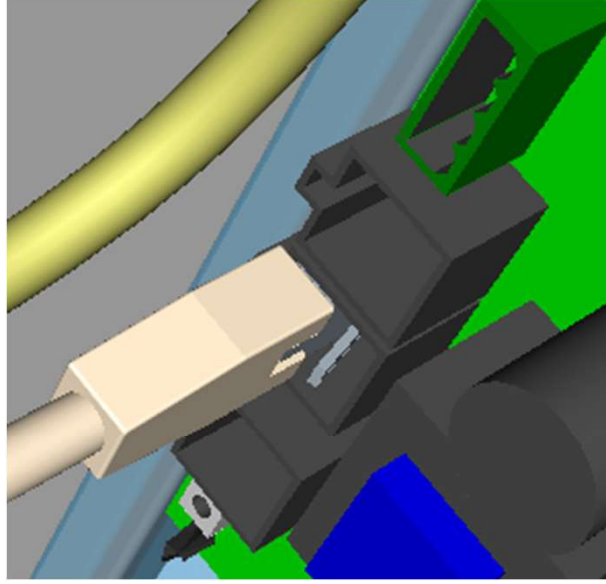













A07	Temperature probe failure	The prover interrupts any operation in progress	<ul style="list-style-type: none"> <li>Temperature probe has failed</li> <li>Prover's board failure</li> </ul>	<ul style="list-style-type: none"> <li>Replace the temperature probe</li> <li>Replace the prover's board</li> </ul>	<ul style="list-style-type: none"> <li>KTR1105A</li> <li>KPE1065B</li> </ul>
-----	---------------------------	---	--	---	--

### 3.1 Alarm and warning messages

U01	Oven PCB Temperature Warning	The temperature of the PCB exceeds 70°C, the oven will continue the operation in progress	<ul style="list-style-type: none"> <li>Oven not correctly positioned to the kitchen</li> <li>Damaged rear cooling fan</li> <li>Damaged oven PCB</li> </ul>	<ul style="list-style-type: none"> <li>Refer to the «positioning» step at the installation slides</li> <li>Replace the cooling fan</li> <li>Replace the oven PCB</li> </ul>	<ul style="list-style-type: none"> <li>KVN1120B</li> <li>KPE1983A (Dynamic-Matic), KPE2010A (Classic)</li> </ul>
-----	------------------------------	---	--	---	--

## 3.2 Hidden menu

- Press  and  together for 5 seconds
- Press  to choose the net addresses. As for the Chef Top and Baker Top ovens the NET addresses are
  - 1 Power board
  - 10 Display board
- Press  to enter into the single board setup
- Press  and  to recall the parameter to adjust
- Press  again to enter the parameter setting
- Press  and  to change the parameter value
- Hold the  button for at least 5 seconds at the end of each modification to save the setting
- Press  two times to exit from each hidden menu

*Dynamic*

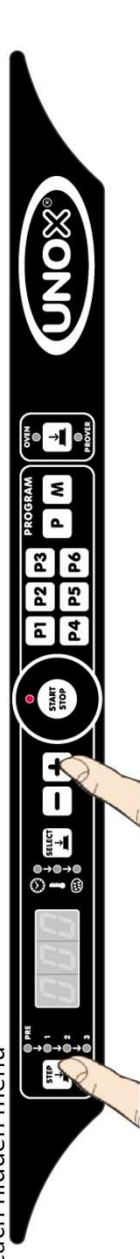

*Matic*

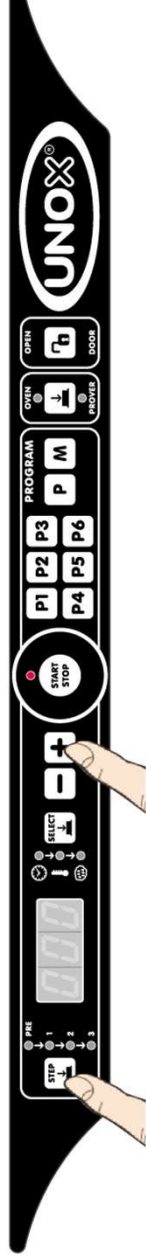

*Classic*

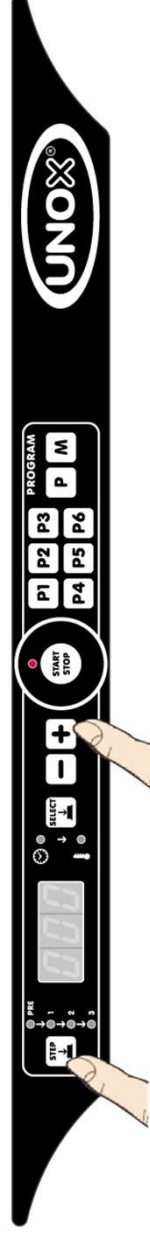

## 3.2 Hidden menu

### 10 – Display board hidden menu

Board code	Parameter name	Description
PE1980B0	FRW	Firmware
PE1980B0	CD1	Display board code
PE1980B0	CD2	Display board version
PE1980B0	NET	Net address
PE1980B0	OV	Master & Slave - Not used
PE1980B0	SNB	Board serial number
PE1980B0	TDB	Assembly line test date
PE1980B0	TTB	Assembly line test time
PE1980B0	TYP	Tic = Matic   Din = Dynamic   Cla = Classic
PE1980B0	DEG	Celsius or Farenheit
PE1980B0	H20	Pump or water solenoid activation
PE1980B0	LOC	Lock of first 20 programs (1-20)
PE1980B0	MOD	Oven mode – not used
PE1980B0	LMP	Lamp activation
PE1980B0	STB	Stand-by activation
PE1980B0	PRG	Manual setting activation
PE1980B0	FOB	Buzzer frequency (not used)
PE1980B0	TMP	Not used
PE1980B0	LTM	Not used
PE1980B0	VEL	Motor(s) speed
PE1980B0	ODF	Automatic door closure (not used)
PE1980B0	SEN	Touch buttons sensitivity (standard = 8)
PE1980B0	RIC	Touch buttons calibration – (standard = 2)

## 3.2 Hidden menu

### 1 – Power board hidden menu

Board code	Parameter name	Description
PE1983A0/PE1964A0	FRW	Firmware
PE1983A0/PE1964A0	CD1	Power board code
PE1983A0/PE1964A0	CD2	Power board version
PE1983A0/PE1964A0	NET	Net address
PE1983A0/PE1964A0	SNB	Serial Number board
PE1983A0/PE1964A0	TDB	Power board test date
PE1983A0/PE1964A0	TTB	Power board test time
PE1983A0/PE1964A0	SND	Oven serial number
PE1983A0/PE1964A0	TDD	Assembly line test date
PE1983A0/PE1964A0	TTD	Assembly line test time
PE1983A0/PE1964A0	MAS	Maximum setpoint temperature
PE1983A0/PE1964A0	RES	Heating element activation
PE1983A0/PE1964A0	HRD	Working hour alarm (not used)
PE1983A0/PE1964A0	TMD	Maximum temperature reached from the power board
PE1983A0/PE1964A0	DF1	Isteresis regulation of the temperature probe
PE1983A0/PE1964A0	OF1	Oven probe offset
PE1983A0/PE1964A0	OFL	Prover probe offset
PE1983A0/PE1964A0	MOD	Oven model (not used)

### 3.3 Upgrading procedure

- 1) Connect the data cable of the XC236 Usb Interface behind the unit, to the available port of the rear power board
- 
- 2) turn ON the oven power supply
  - 3) once the software has loaded and the display panel shows 000, hold STEP+SELECT together for 5 seconds and wait for RPG (Reprogramming): do not disconnect the Usb stick, data cable, oven power supply while the process has been started
  - 4) turn OFF then back ON the main power supply
  - 5) disconnect the Usb bridge

