



SERVICE TRAINING
English

LineMiss™



- 1 Installation Guide**
- 2 Hidden Menu Guide**
- 3 Maintenance Guide**



LINE MISS 800 – 600 SERIES

Dynamic

SERVICE TRAINING

English

LineMiss™

Dear Sirs,

The following Service Training slides introduce the installation steps for the Unox Line Miss 800-600 series models.

To insure that the Line Miss electric units are at their optimal efficiency, functionality, and reliability it is imperative that all of the installations steps and procedures are followed as describe in the installations slides.

Thomas Fracasso
Technical Service Manager

UNOX LineMiss Ovens - Features

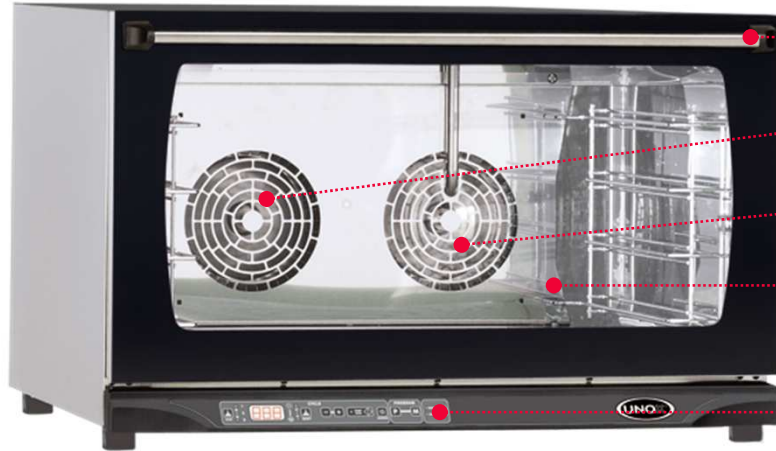

Simple and safe handling

AIR.Bake

Auto-reversing motors combined with high speed revolving fans

STEAM.Bake

Instant humidity creation inside the oven chamber from a temperature of 90 °C

Oven chamber cleaning

Oven chamber built in stainless steel with rounded corners

Easy extraction of the lateral grid supports

Control

Dynamic, Classic, Matic and Manual

Gasket
Made with the most professional material and fastened into an airtight slot.

Lighting
Long life halogen lamp

Micro safety switch

Hinges with perfect balancing and soft closing
Tested for more than 100.000 openings

Protek.SAFE™
The cool touch oven door has an air space between two glass panels to provide a colder external glass temperature.
Internal glass temperature 260 ° C
External glass temperature 60°C

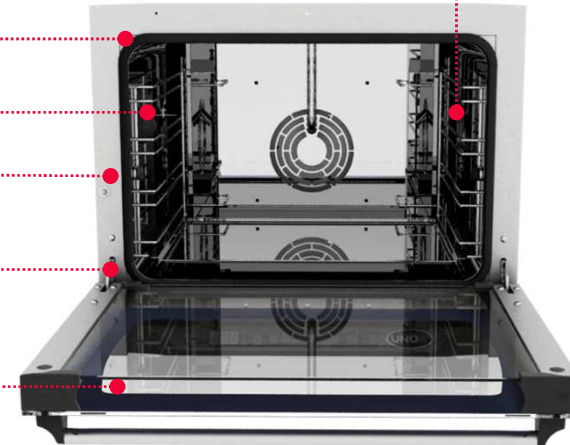

UNOX LineMiss Ovens – Control Panel Features

Dynamic



Matic



- | | |
|--|---|
| 1 - key to select baking step | 8 - baking parameters increase / decrease key |
| 2 - baking step LED | 9 - START/STOP baking cycle |
| 3 - display to visualize the baking parameters | 10 - key to add water, manually STEAM.Maxy™ |
| 4 - baking time LED | 11 - program menu recall key |
| 5 - baking temperature LED | 12 - program memorization key |
| 6 - humidity LED | 13a - key to select oven, prover |
| 7 - time, temperature, humidity select key | 13b - key to lock and unlock the oven door |

Classic



- | | |
|---|--|
| 1- display to visualize the baking parameters | 5- baking parameters increase / decrease key |
| 2- baking time LED | 6- START/STOP baking cycle |
| 3- baking temperature LED | 7- program menu recall key |
| 4- time / temperature select key | 8- program memorization key |

Manual



- | |
|--|
| 1- setting baking time |
| 2- temperature control |
| 3- LED to switch on the oven |
| 4- button to put into action the STEAM.Maxy™ |

AIR.Plus

Air is the medium for the heat transmission and thereafter the means to bake products. The performance of air flow is fundamental to obtain uniformity of baking in all the points of the single tray and in all the trays.

For this reason the air flow inside the chamber plays a leading role in the design of all UNOX **LineMiss™** ovens.

The **AIR.Plus** technology has been designed by UNOX to obtain perfect distribution of the air and heat inside the baking chamber.

At the end of the baking, thanks to the **AIR.Plus** technology, foods have a uniform external color and their consistency will remain intact for several hours.

The **AIR.Plus** technology ensures perfect uniformity within every single pan, on all trays, from the top one to the bottom one.

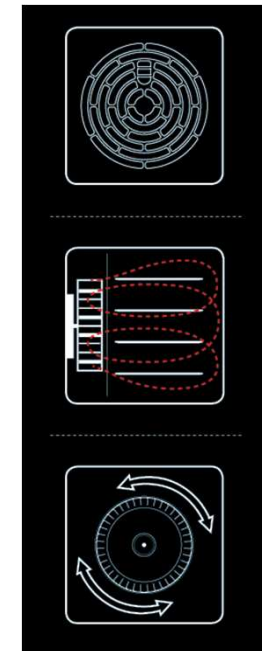

Air reduction kit:

To guarantee the best cooking results for products with a light mass, such as puff pastry and meringue, the products cannot be damaged by the air movement inside the cavity. To control the air UNOX has developed a specialized air reduction kit.



STEAM.Plus

The use of humidity is increasingly spread in the Bakery and Pastry bakings.

The humidity introduced in the chamber during the first minutes of the leavened products baking process promotes the internal structure development and the goldening of the external surface of the product.

The **STEAM.Plus** technology allows the ability to have humidity inside the oven chamber from a lower temperature of 90° to an higher one of 260 °C.

In the **LineMiss™ Dynamic** ovens the release of humidity can be set with the baking program or manually with a button.

In the **LineMiss™ Manual** Humidity the release of humidity is activated with a dedicated button.

DRY.Plus

The presence of humidity during the last phases of the baking of leaven products can compromise the achievement of the desired result.

DRY.Plus technology allows the rapid extraction of the humidity from the baking chamber, both the one released by the food and the one eventually generated by **STEAM.Plus** technology in a previous baking step.

DRY.Plus technology ensures the texture of the baked products, allowing to obtain a dry and well structured internal structure and a crisp and crumbly external surface.

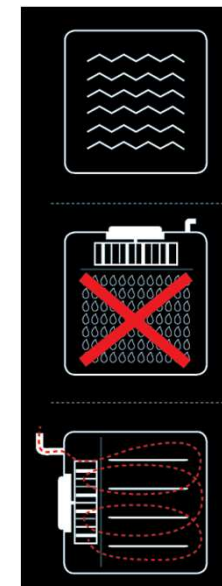
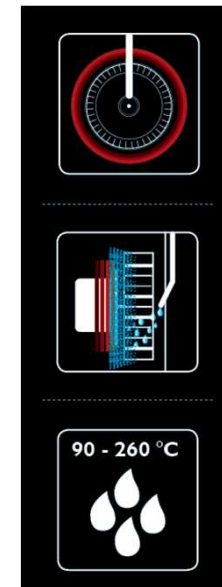



1 Installation Guide

- 1.1 Introduction
- 1.2 Positioning
- 1.3 MAXY.Link – Stack 2 or more ovens to complementary accessories
- 1.4 MAXY.Link stacking kit installation
- 1.5 Electric power supply connections – 600 series models
- 1.6 Electric power supply connections – 800 series models
- 1.7 Checking the electric connections
- 1.8 STEAM.Maxy – Water inlet quality
- 1.9 STEAM.Maxy – Water inlet connection
- 1.10 Oven cavity smoke exhaust
- 1.11 Unox condensation hood installation

SERVICE TRAINING

English

1.1 Introduction

The oven's installation is divided into 4 parts:

- 1 Positioning
- 2 Electric connections
- 3 Water inlet
- 4 Exhausts



1.2 Positioning

- Line Miss ovens are not suitable for built-in installation.
- Distances:
 - It is mandatory to leave 5 cm (10 cm recommended) of free room all around the appliance in order to guarantee the heat dissipation.
 - It is mandatory to leave 70 cm of distance between the unit and sources of hot liquid drops, such as fryers or similar appliances.
- If the appliance is placed near walls, partitions, kitchen cabinets, decorated edges, etc., it is recommended these are made of non combustible material. Otherwise, they must be coated with non combustible thermal insulating material and the fire prevention standards must be respected.
- In case of impossibility to keep the reported distances, place a separation between the oven case and the fryers**

Oven – walls distances

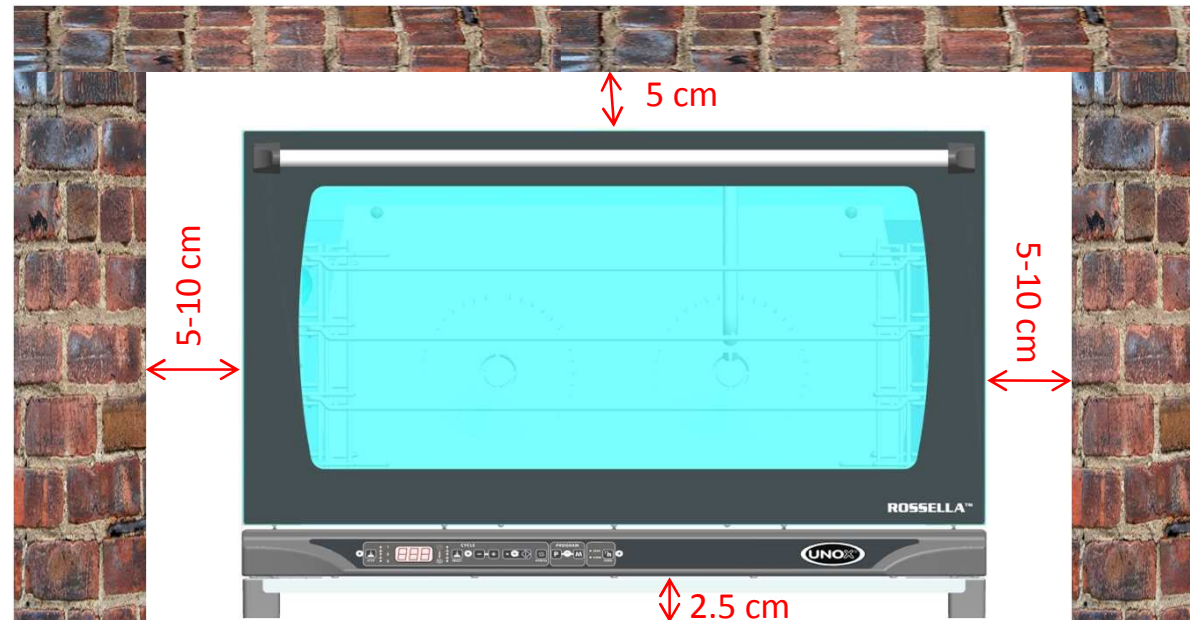

Oven – fryer distances

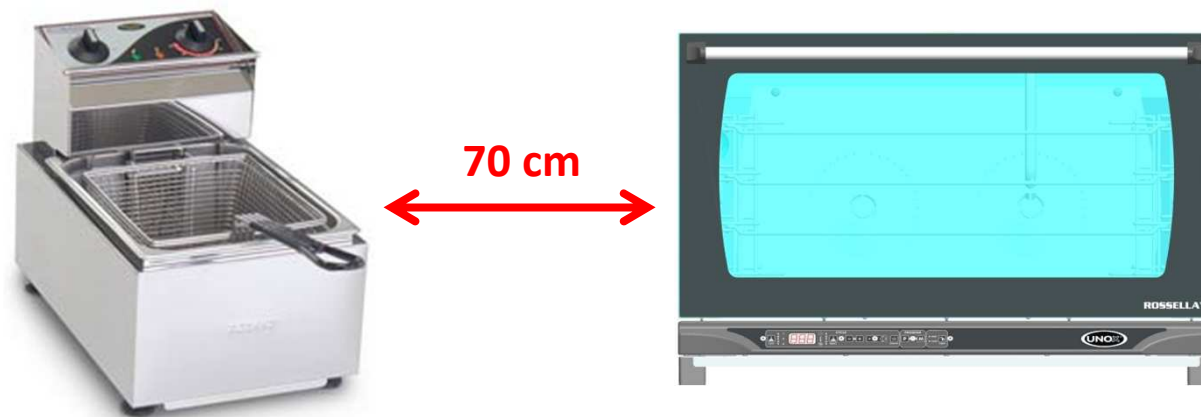

1.2 Positioning

- Carefully remove all the protective film from the external walls of the appliance. Be careful to not leave any residue of glue. If there should be any residue of glue please remove it with an appropriate solvent.
- You will find the feet inside the appliance. They must be fitted to the oven. Never use the appliance without its feet, since they're made to grant a proper fresh air flow that cools down the electronic circuits and the walls of the unit.

Feet

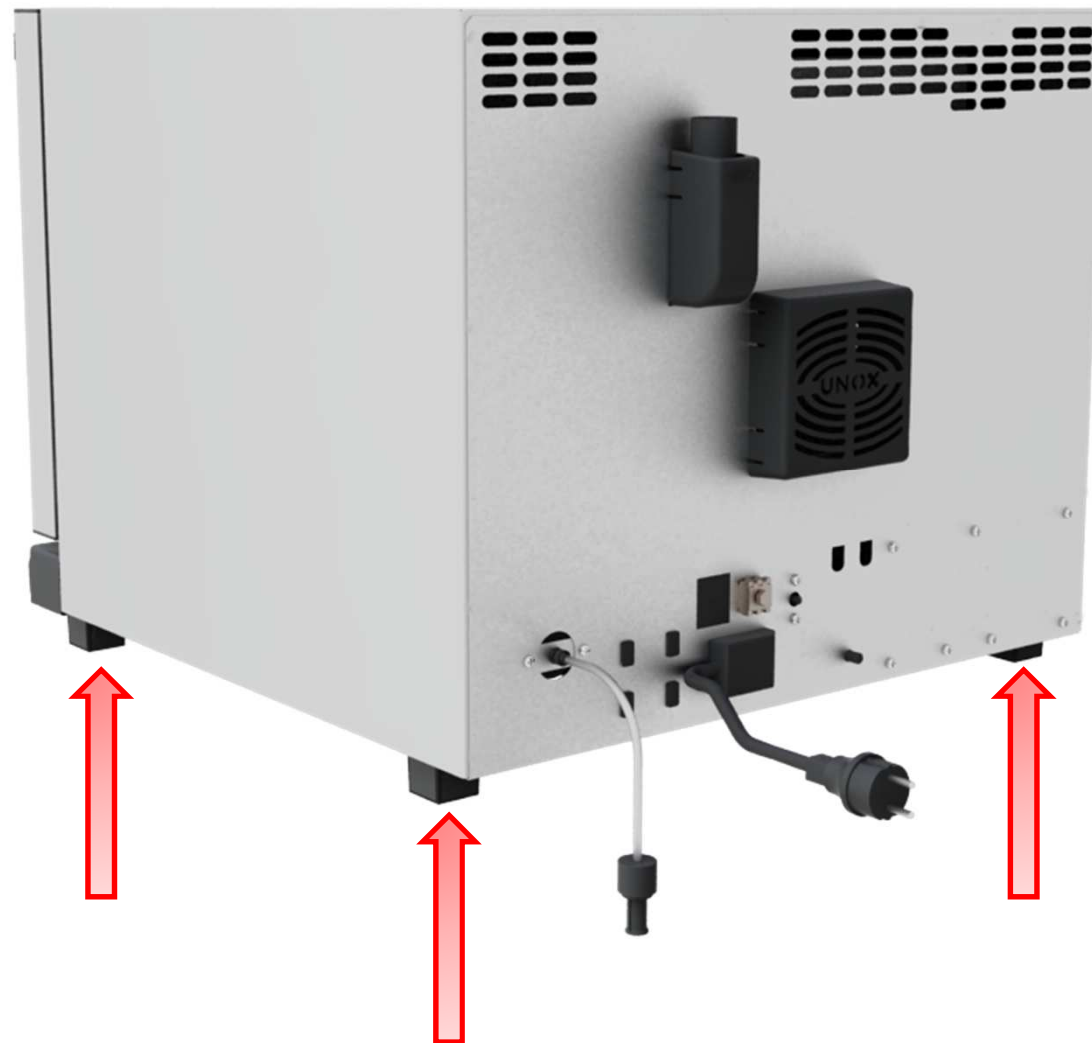

1.3 MAXI.Link

Stack two or more ovens to complementary accessories

- It is mandatory to use the proper stacking kit to stack two ovens.
- In the kit box there are all the necessary items to assembly it.

Stacking kit

XR 615 LineMiss 460 x 330

XR 646 LineMiss 600 x 400

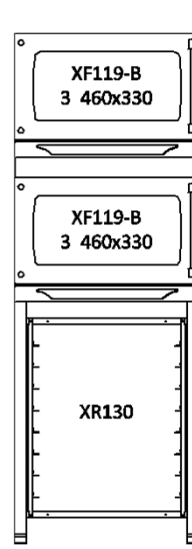

6 460 X 330

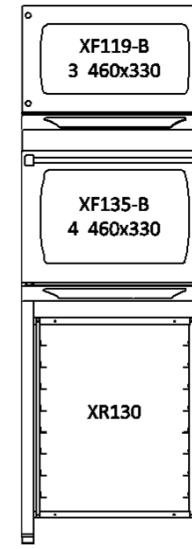

7 460 X 330

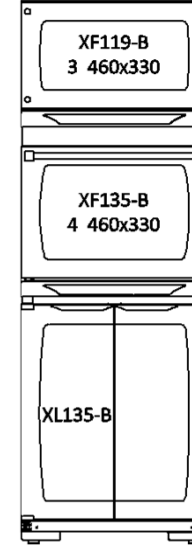

7 460 X 330

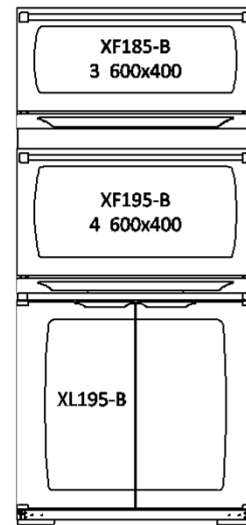

7 600 X 400

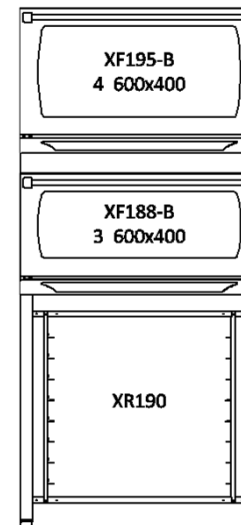

7 600 X 400

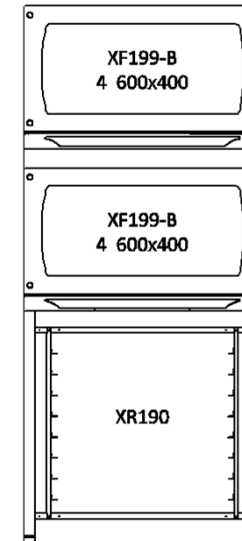

8 600 X 400

1.4 MAXY.Link – stacking kit installation

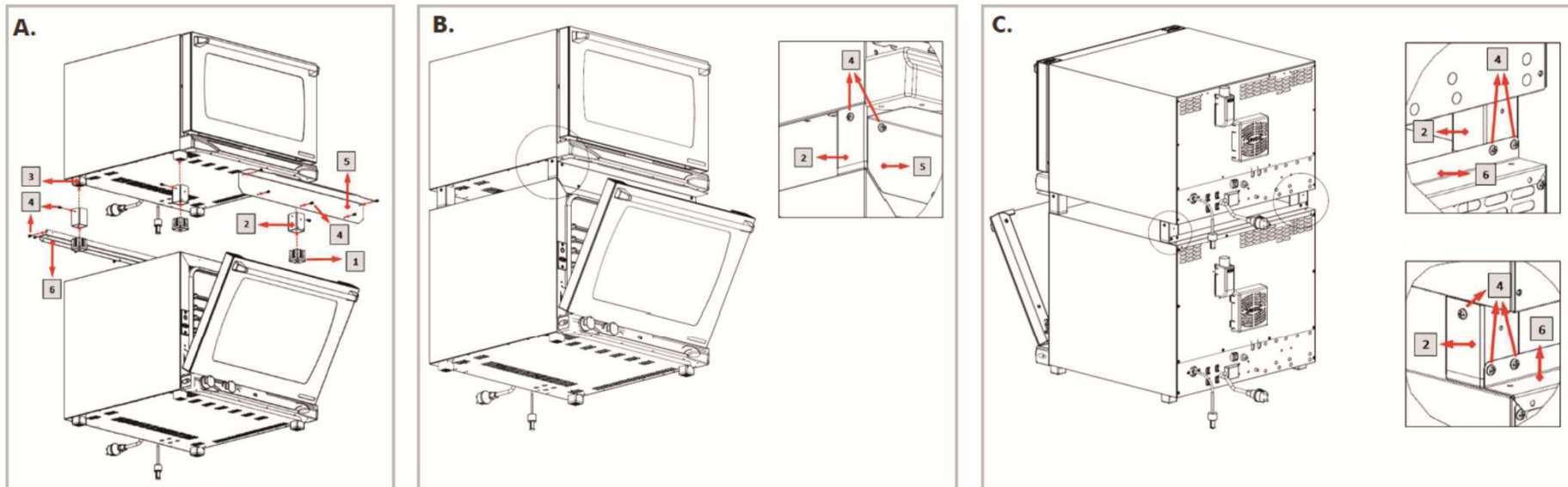

Step 1. Insert the black caps (1) on the bottom of the 40 x 40 mm stainless steel tubes (2). Picture A.

Step 2. Fix the 4 stainless steel tubes to the upper oven feet (3) by using the proper screws (4). Picture A.

Step 3. Place the oven with the fixed 4 tubes over the lower oven. Picture A.

Step 4. Place the front heat-guard plate (5) on the front upper side of the lower oven then fix it with the supplied self-threading screws (4). Picture A.

Step 5. Place the fixing plate (6) on the back side of the lower oven, and fix it with the self-threading screws (4) on both sides of the indicated positions. Picture A.

Step 6. Fix the front heat-guard plate (5) to the 2 front tubes (2) with the 2 proper screws (4). Picture B-C.

Step 7. Fix the fixing plate (6) to the 2 back tubes (2) with the 4 proper screws (4). Picture C.

1.5 Electric power supply connection – 600 series models

- All the electric components, like motors, STEAM.Maxi valve, back power card, contactors , heating element use 220 V as voltage.
- The connection to the electrical power supply system must be carried out according to the current local regulations.
- Before connecting the appliance, make sure that the voltage and the frequency correspond to those stated on the data plate of the appliance.
- **Place an isolation switch** between the appliance and the network in such a way that it will be easily accessible after the installation.
- **Each unit must have its own switch. Never connect two units to the same switch.**
- The appliance must be connected to the electricity mains earth conductor.
- The appliance must be included in an equipotential system whose efficiency must be properly checked according to the current laws. This connection must be done between different appliances through the terminal marked with the appropriate equipotential symbol. The equipotential conductor must have a minimum section of 10 mm².

Single phase – electric power supply



Electrical connections



Main circuit breaker box



1.6 Electric power supply connection – 800 series models

Three phase – electric power supply

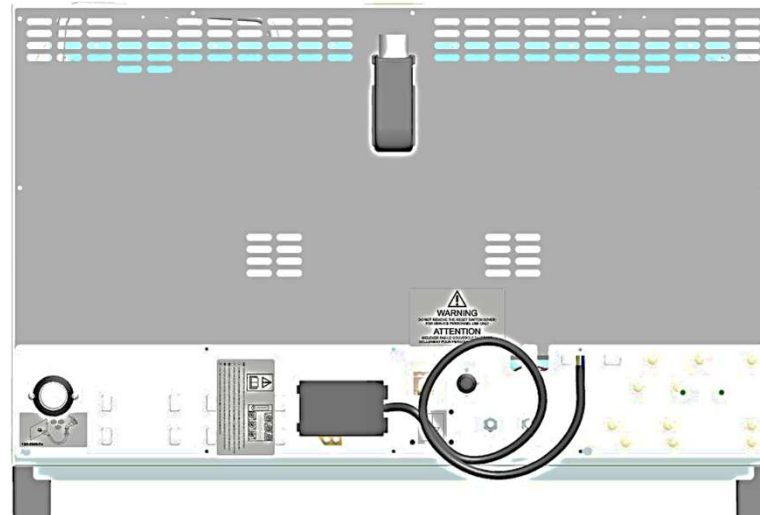

Electrical connections



Main circuit breaker box



1.7 Checking the electric connections

1. Check that the actual AMPs absorbtion of every phase is the same as the one reported in the technical data sheet.
2. Check the absence of electrical leakage.
3. Check the continuity between the wall of the unit and the ground wire.
4. A digital multimeter is recommended in performing this operation.
5. Before the shipment an accurate test is made to grant the security of the oven. It is anyway recommended that all these checks are made to grant the security and to verify the correctness of the electrical connections.

Technical Data Sheet

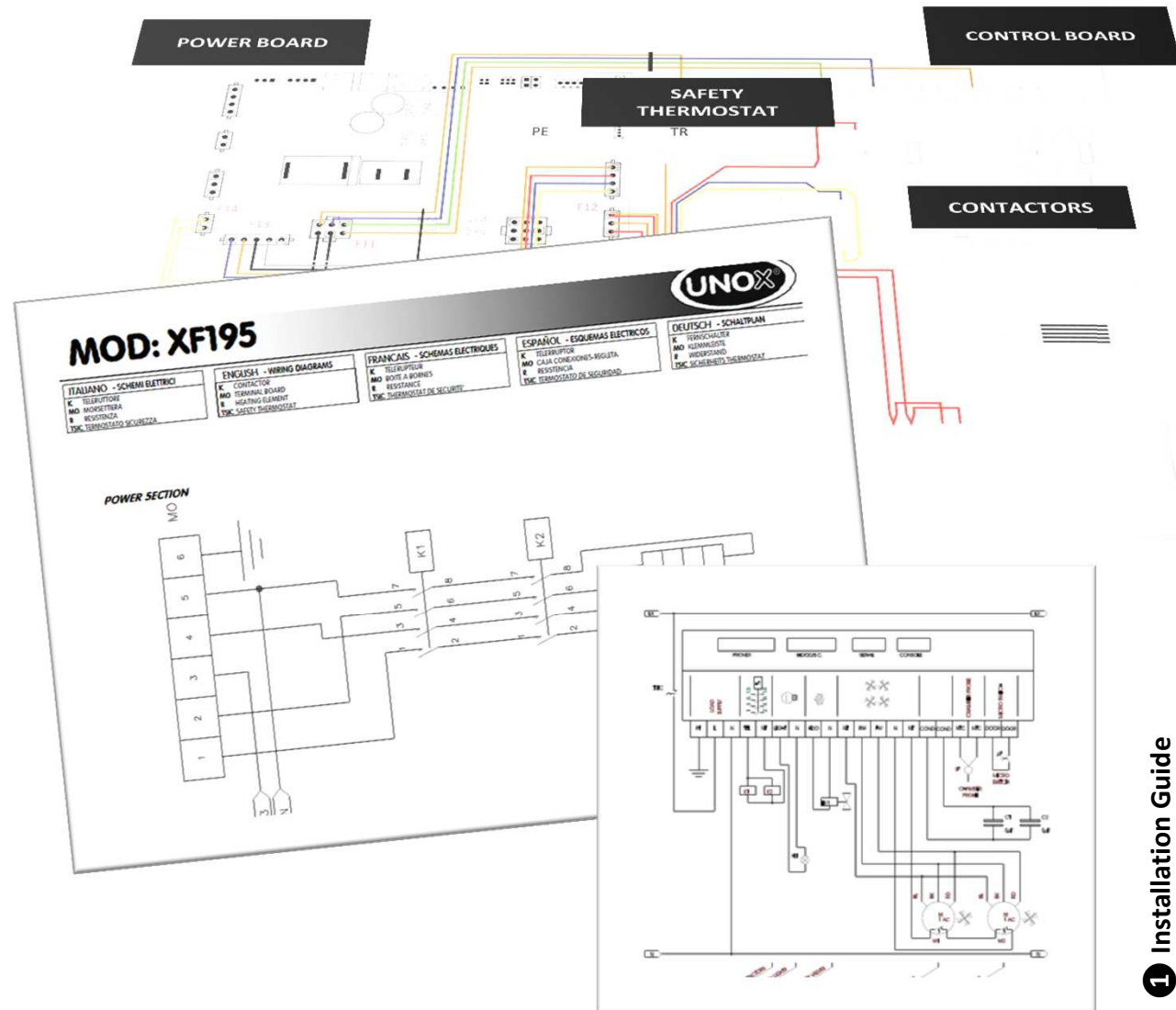

1.8 STEAM.Maxi™ Water Inlet quality

- To produce steam using the STEAM.Plus technology LineMiss ovens have to be connected to the water supply.
- Before connecting the water pipe to the appliance please let some water flow to clear the pipe of any obstructions that can damage the water valves inside the STEAM.Maxi circuit.
- **Verify water hardness:**
 - It's value should not be higher than $150\mu\text{S}/\text{cm}$.
 - If the value is higher, it is mandatory to use a proper water purifier.

Water in connection

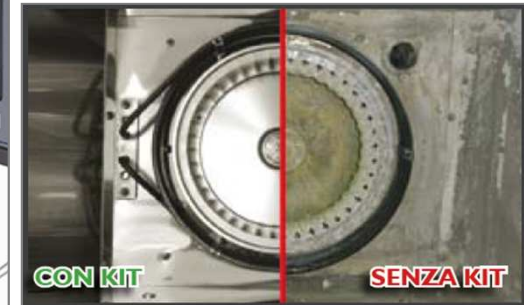
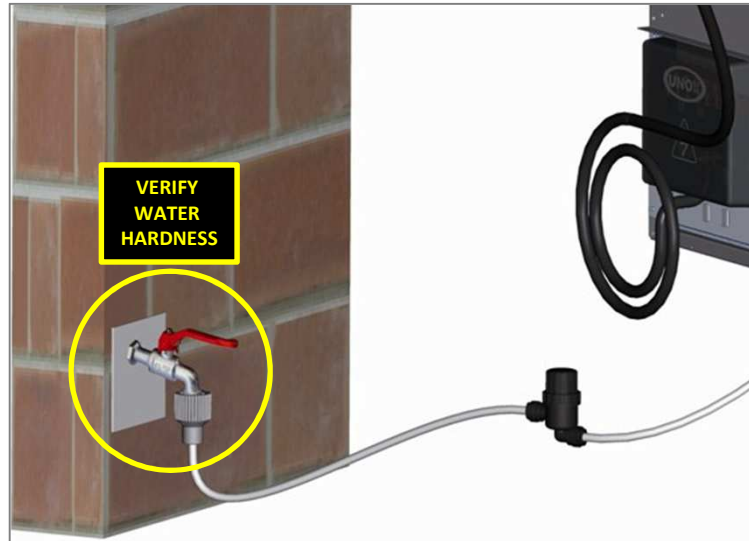

Poor water quality effect

- It is possible that some iron particles are dissolved in the water and they can create the formation of rust in the cooking chamber. The only system to remove these particles from the water is a reverse osmosis system.
- It is recommended to use an osmotic membrane filter in order to avoid limestone and/or other minerals depositing particles inside the oven and grant the maximum durability of the unit itself.



1.9 STEAM.Maxi™ Water Inlet connection

- Water inlet pressure must be not higher than 2 bars and not lower than 1,5 bar.
- To the LM 800 series connectio, if the inlet water pressure is too low, replace the water solenoid with the pump kit XC665.
- The XC665 kit can be used when there is no water supply. A pump can be fitted in the unit in order to source water from a tank. The maximum capacity of the pump is 14 l/h.

LineMiss 600: pipe provided

LineMiss 800: non-return valve provided

Both pipe and non-return valve installations are available for LineMiss 460x330 and 600x400

**Pump inlet pipe and weight -
supplied as default to LM 600 series**



**3/4 inlet water solenoid -
supplied as default to LM 800
series**

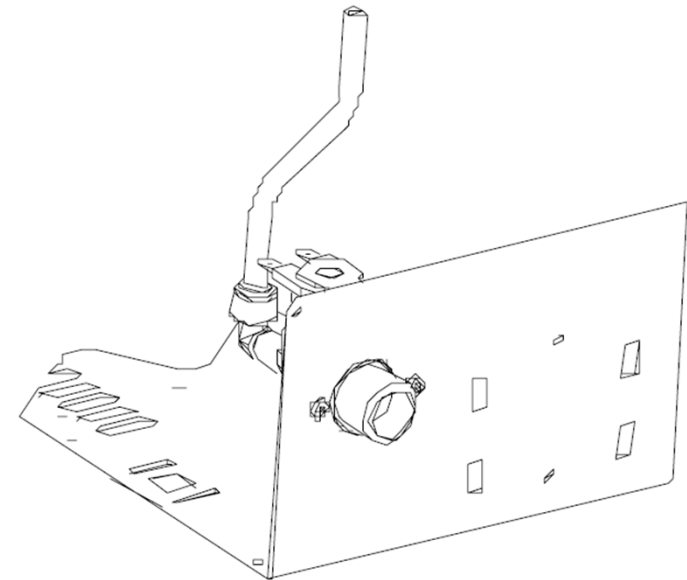

1.10 Oven cavity smoke exhaust

- The 30 mm diameter exhaust outlet of the cooking chamber is positioned on the rear of the oven.
- When possible, avoid the extraction of the exhaust using a simple tube. When it is not avoidable, **extract the fumes through the UNOX tube**, code TB1520A0, avoiding tight bends in the pipe work run. They should all have a minimum incline of 45° in relation to the ground. (Picture A)
- Ensure that the exhaust outlet is correctly vented and the vicinity of the outlet is clear of objects and materials that may be damaged by the fumes. **Avoid tube lengths of more than 1 metre**, as there is a risk of condensation of steam within the pipe causing a backflow of the exhaust into the oven. (Picture A)
- It is suggested to place the oven below an extraction hood or to install the UNOX Aspiration and Condensation hood. (Picture B)

Exhausts pipe

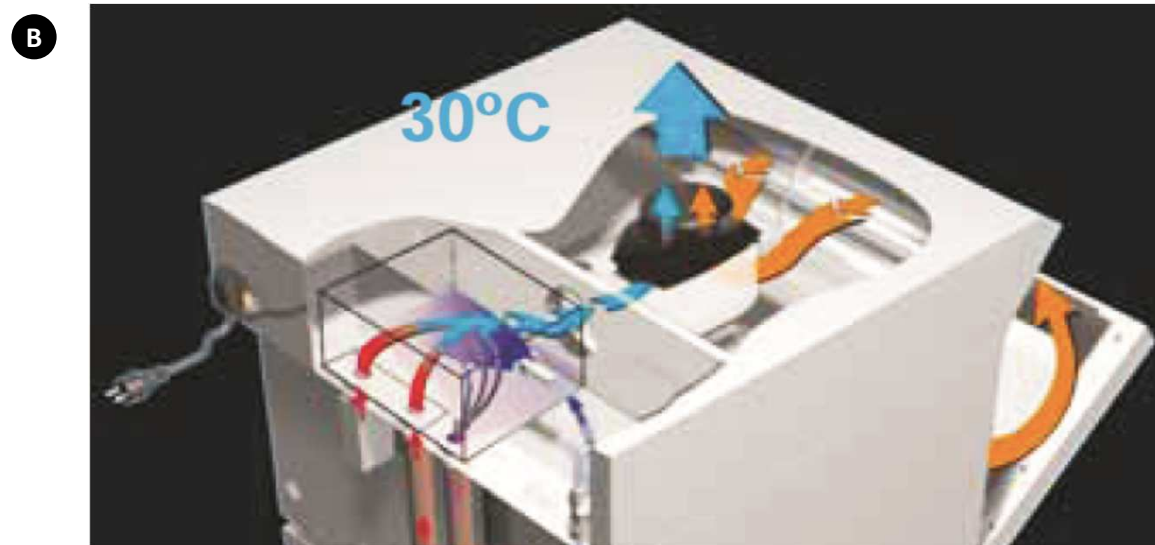
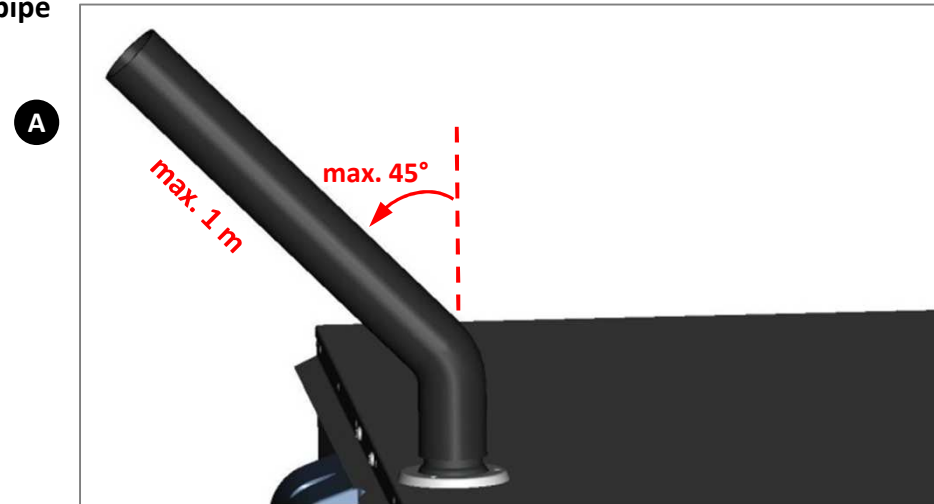

1.11 Unox condensation hood installation

Positioning:

- Place the hood on the top of the oven and fix it with the screws supplied (A).
- To fix the front part of the hood to the oven use the proper self-tapping screws that you find on the top front part of the oven (B).
- To fix the back part of the hood to the oven use the fixing screws that you find on the top back part of the oven (B).

Electrical Connection: The appliance must be connected to 230-250V single phase socket with earth connection.

Water Connection:

- It is necessary to place a mechanical filter and a shut-off valve between the water system and the appliance.
- As required by current laws, the appliance is equipped with 2 metres of water inlet pipe, the respective pipe fitting (3/4") with non-return valve and mechanical filter.
- Before connecting the water pipe to the appliance please let some water flow to clear the pipe of any obstructions.

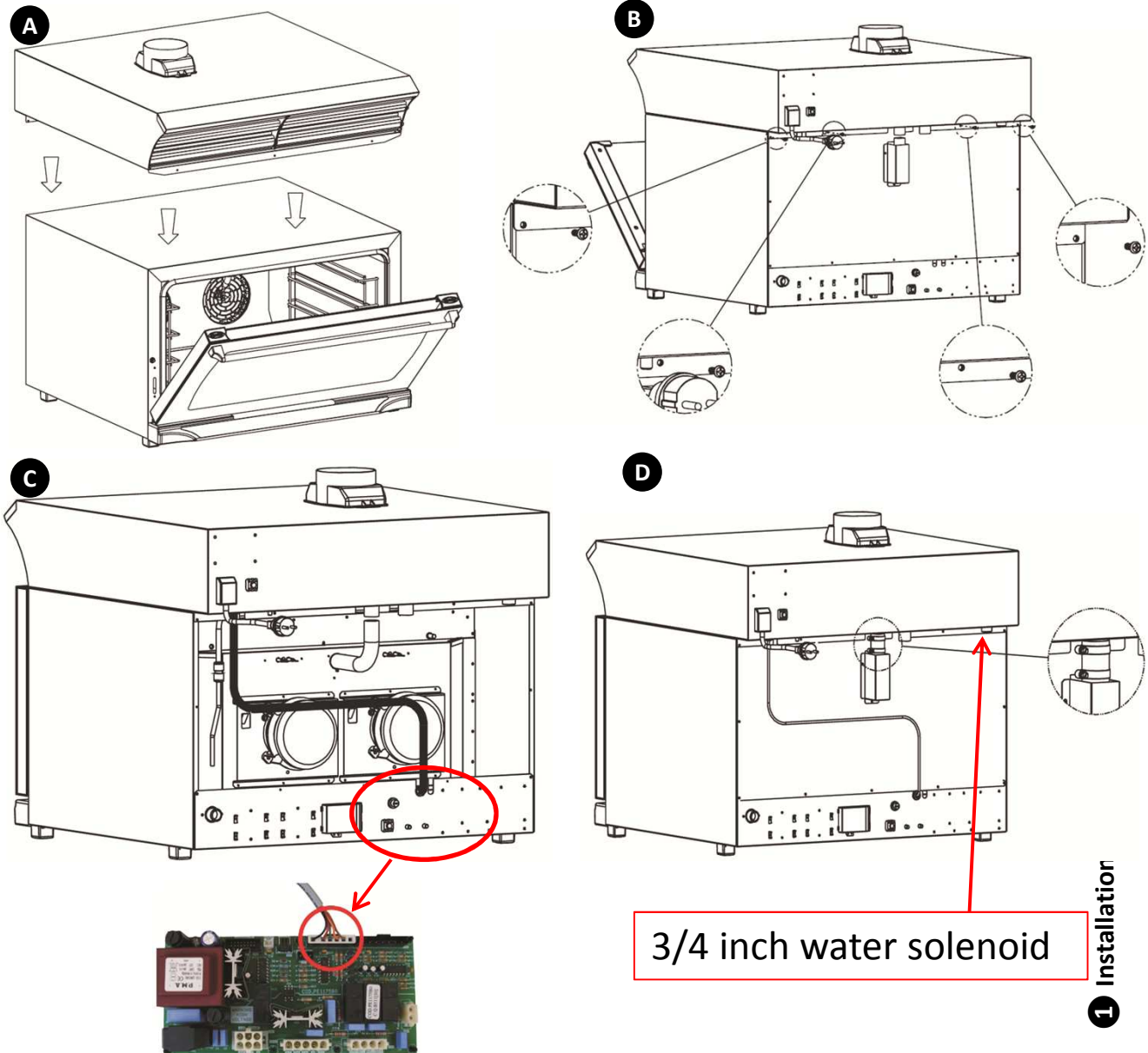

1.12 Unox reverse osmosis kit connections

Electrical Connection: same procedure of ovens.

Water connection (water inlet):

- It is necessary to place a shut-off valve between the water system and the appliance.
- Disconnected the pipe from the oven and connected to the water inlet of the reverse osmosis kits system (you find a \varnothing 8 mm quick connection on the reverse osmosis kits system).
- Before connecting the water pipe to the appliance please let some water flow to clear the pipe of any obstructions.
- In case of the inlet pressure is under 4 bar, add a pressure reducer setted to 2 bar.

Water connection (outlet water):

- Connect the treated water outlet ("TREATED WATER") to the oven inlet by using the \varnothing 8 mm pipe supplied.
- The waste water outlet ("WASTE WATER") has to be connected to a water drain using the \varnothing 6 mm pipe supplied.
- Because of sudden pressure changes that may occur this pipe can move: for this reason it has to be firmly fixed to the water drain.

Connection to the oven:

- The reverse osmosis kits system is connected to the oven through the RJ45 connectors that are located at the rear of the oven.

Water treatment process

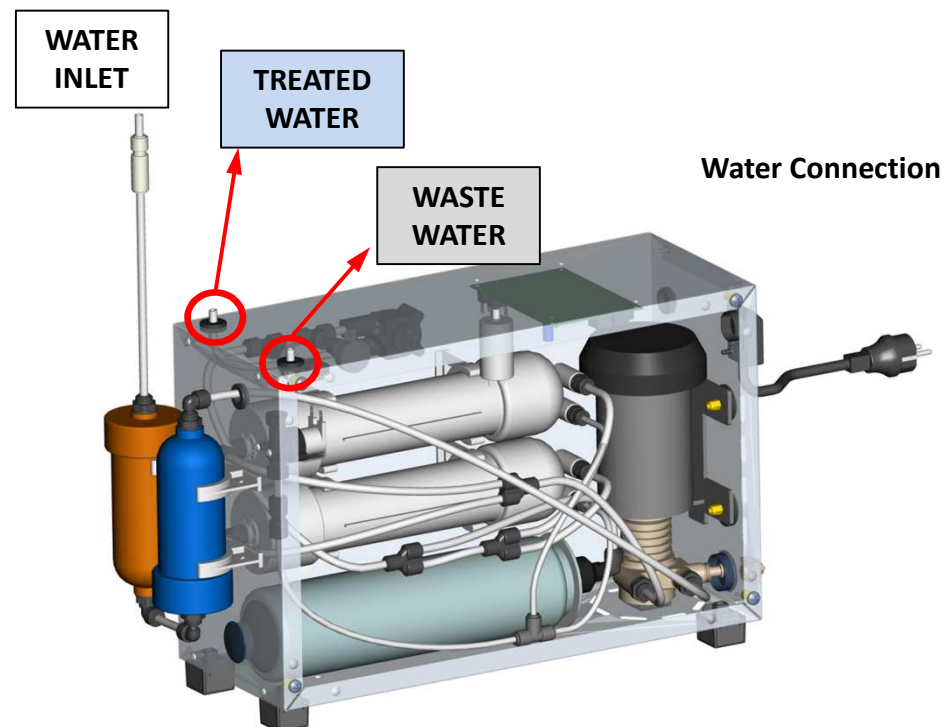
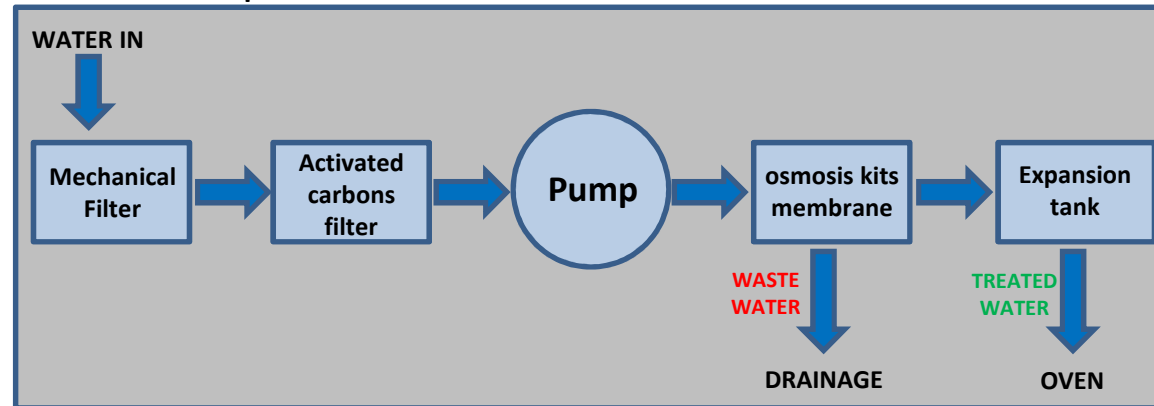



2 Hidden Menu Guide

2.1 Control board hidden menu

SERVICE TRAINING

English

2.1 Control board hidden menu

- To enter at the hidden menu press the **[-][+]** buttons simultaneously for 5 seconds.
- The first display visualization will be REL /206, press SELECT to skip the single hidden menu parameters
- With the «+» and «-» buttons change the values of the single parameters
- To save the changes press SELECT to skip all the parameters to get out from the hidden menu
- Note: To store** the new settings disconnect the oven (unplug it), wait for 10 seconds and then re-connect it.

Dynamic



Setting	Description	Range	Default data	Parameters
VER	Firmware version	//	//	Not changeable
t0	Temperature probe offset	-8 / +8 °C	//	This number is added to real temperature of cooking chamber
t1	Prover Cabinet probe offset	-8 / +8 °C	//	This number is added at real temperature of prover chamber
d1	Heating elements hysteresis activation	0 / +8 °C	2	Not changeable
DEG	Celsius or Fahrenheit version	CEL / FAR	CEL	CEL =Celsius degrees FAR =Fahrenheit degrees
RES	Activation of the heating elements	off / on	on	off = turns off heating elements on = turns on heating elements
H2O	Power board setting for solenoid electrovalve or pump	0 / 1	0 for ovens with pump 1 for ovens with valve	0 = pumps 1 = water valve
LOC	Cooking programs lock	0 / 1	0	0 = programs from 51 to 70 can be modified 1 = programs from 51 to 70 can not be modified
MOD	Oven functioning mode	0 / 1	0	0 = normally function 1 = at the end of cooking program the oven works at 180°C in infinite
doo	Electric door opening setting	0 / 1	0 for oven with reverse door 1 for oven with side opening door	0 = reverse door 1 = side opening door
LMP	Light in the cooking chamber	0 / 1	1	0 = the light never turn on 1 = the light turn for 1 minute



3 Maintenance Guide

- 3.1 Trouble shooting chart
- 3.2 Door removal
- 3.3 Hinge replacement
- 3.4 Internal glass replacement
- 3.5 Control board replacement
- 3.6 Power board replacement
- 3.7 Safety switch replacement
- 3.8 Water solenoid replacement
- 3.9 Cavity gasket replacement
- 3.10 Hinges holder and door switch replacement
- 3.11 Fan replacement
- 3.12 Motor replacement
- 3.13 Heating element replacement
- 3.14 Cavity probe replacement
- 3.15 Useful instruments

SERVICE TRAINING

English

L1000A0

3.1 Trouble shooting chart

Trouble Type	Trouble Description	Effects	Possible Causes	Possible solutions
Electric / Electronic	Error Message EE1	The oven stops operating. The display panel shows the error message	Temperature probe disconnected from the back power board	Connect the temperature probe
			Temperature probe not calibrated	Replace the temperature probe
			Defective temperature probe wires	Replace the temperature probe
			Back power board not operating	Replace the power board
Electric / Electronic	No signal tones (buzzer not active)	The oven doesn't make any noise at the end of cooking cycles	Buzzer built into the control board damaged	Replace the Control board
Electric / Electronic	Impossible to input any set from front display board	Impossible to set cooking recipes, use of memorised programs, use of the prover	Front control membrane damaged , water and external substances leaking onto the front display board .	Replace the display board and front control membrane
Electric / Electronic	Display completely switched OFF	Impossible to access all the display functions	Blown safety fuse to the back power board due to a high electrical discharge from the main electric source .	Replace the fuse and check the voltage to the main electric socket
			Missing power supply from electric socket	Check the electric switch, internal wiring and electric socket of the kitchen-shop
Electric / Electronic	Fans always turning	It's not possible to stop the fans of the oven	Power board damaged due to a high electrical discharge from the main source .	Replace the power board
Electric / Electronic	Motors too slow	The motor/s take a long time to reach the top speed.	One or two capacitors not operative.	Replace the capacitor/s
Electric / Electronic	Missing steam generation function	Water not coming through the water solenoid into the oven cavity.	Untreated water blocked the water solenoid internal membrane	Replace the water solenoid and instal a water softner with mechanical filter
Mechanical	Motor/s too noisy	The motor's bearing begin to be noisy during rotation at top speed	Umbalanced motor fan in the cavity due to use of untreated water causing limestone deposits.	Replace the fan and motor.
/	Uneven cooking due to steam and heat leaking from the door.	During the use of the oven, cooking steam and heat escapes from the front door causing slow and uneaven cooking .	Damaged chamber gasket	Replace chamber gasket.
			Damaged door hinges. The door cannot close and seal the chamber .	Replace door hinges

3.2 Door removal

1. Disconnect the equipment from the electrical power supply.

2. Unlock the two door hinges (1)

3. Pull the door up (2) and extract the two door hinges from the proper holders (3)

1

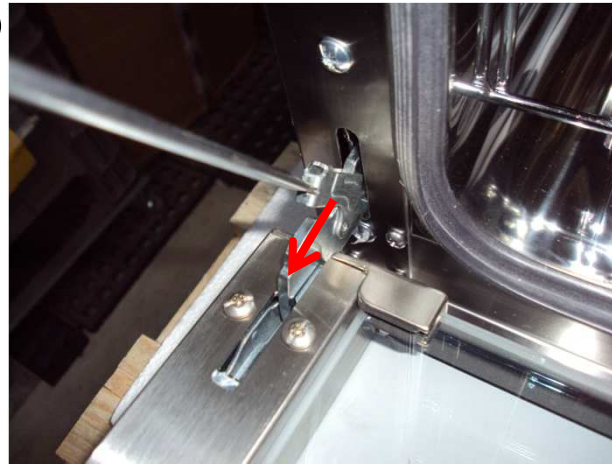

2



3



3.3 Hinge replacement

- Remove the 3 screws locking the hinge to the door frame (1)
- Extract the hinge and aluminium corner from the door frame

1



2

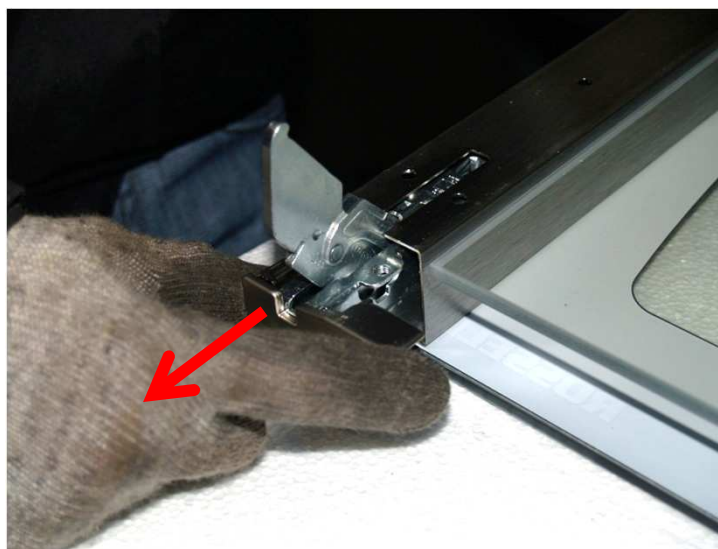

3.4 Internal glass replacement

- Perform the hinge replacement part
- Extract the inner glass from the aluminium corners (1)
- Take off the internal glass completely (2)

1



2

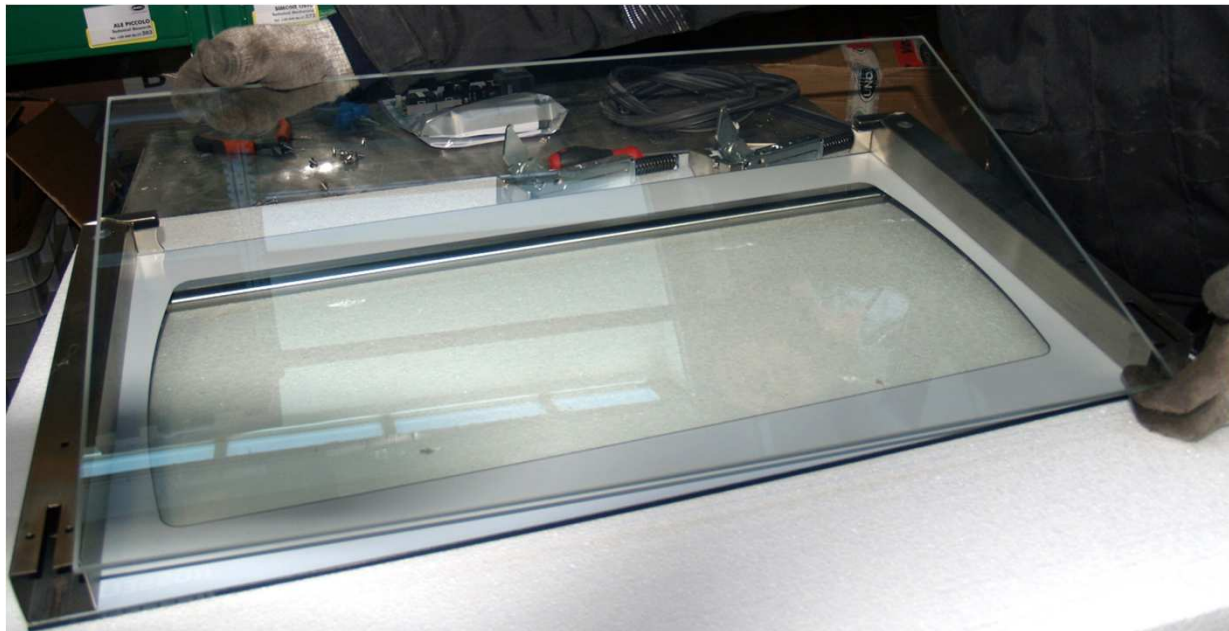

3.5 Control board replacement

- 1. Disconnect the equipment from the electrical power supply.
- 2. Remove the mounting screws of the front display board box (1) (2).
- 3. Pull the display board box down and turn it to extract the display board.
- Using pliers press the plastic tabs to unlock the power board(4).

1



2



3



4

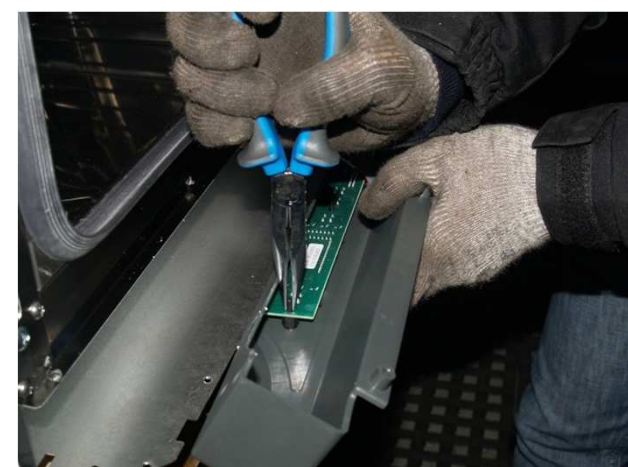

3.5 Control board replacement

- Extract the display card from the grey control box
- Disconnect the display card flat cable from the back PCB

5



6

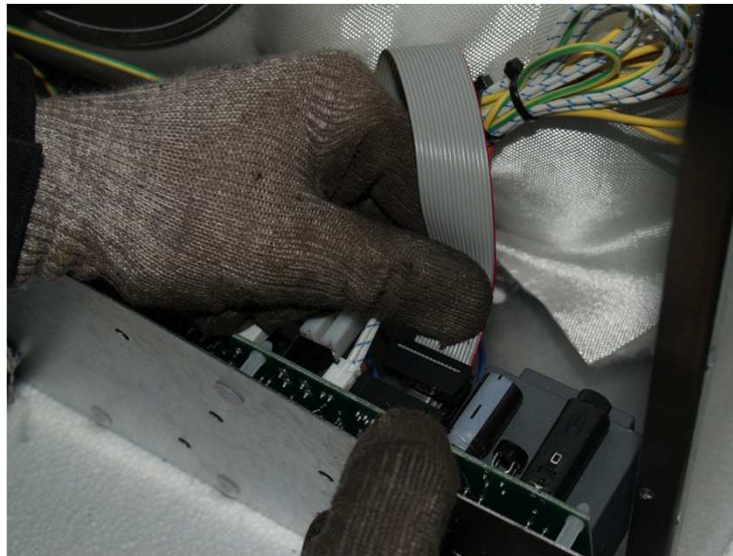

3.6 Power board replacement

- Disconnect the equipment from the electrical power supply.
- Remove the back protection to access to the electric wiring connections (1) (2).
- Disconnect all the wires (3) (4)

1



2



3

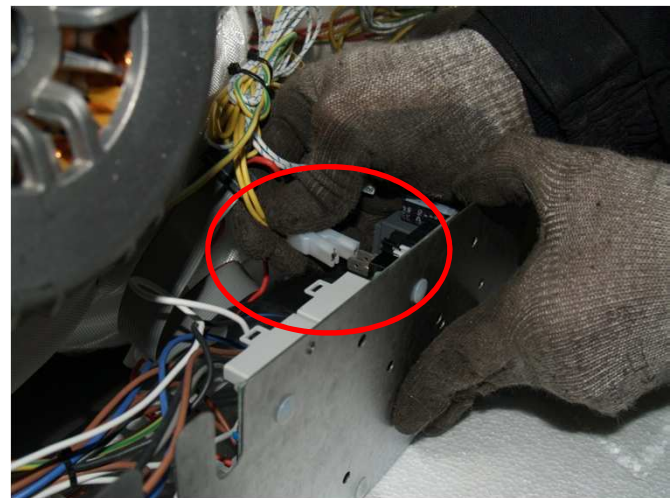

4

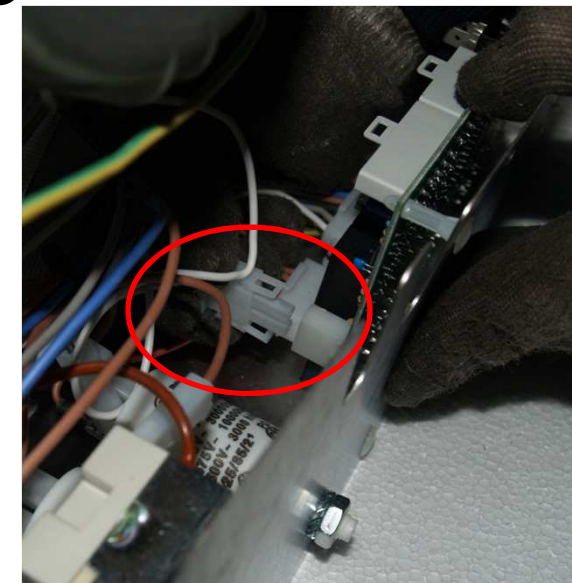

3.6 Power board replacement

- Cut the back power board supports and place the new ones supplied in the replacement kit (5).

5

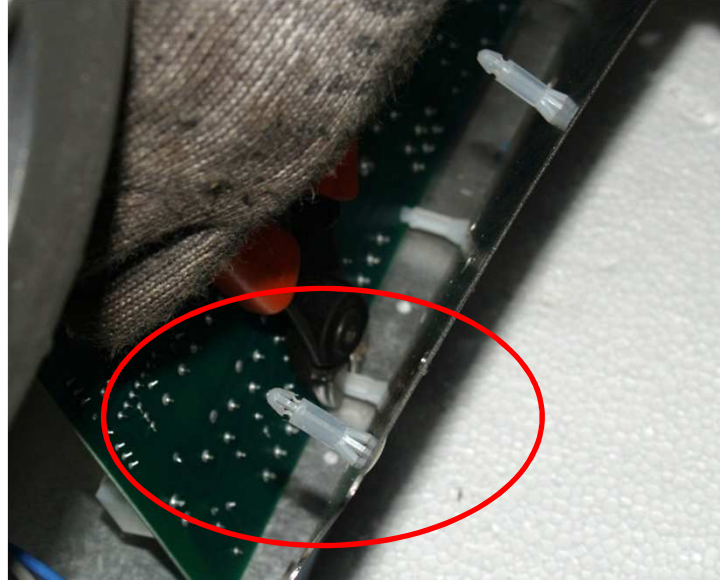

6



3.7 Safety switch replacement

- Unlock the nut and extract the safety switch (1) (2).
- Extract the safety switch probe from the back cavity support hidden by the insulation (3).

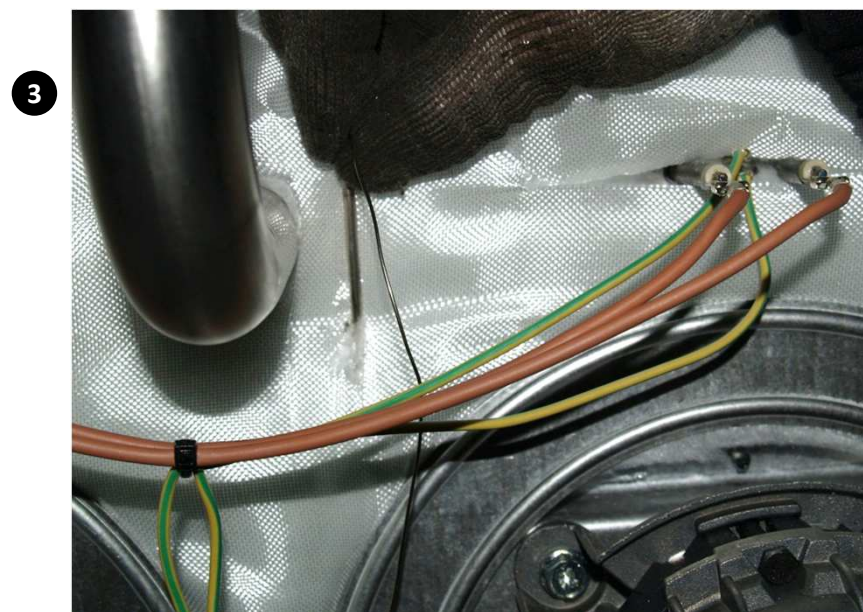
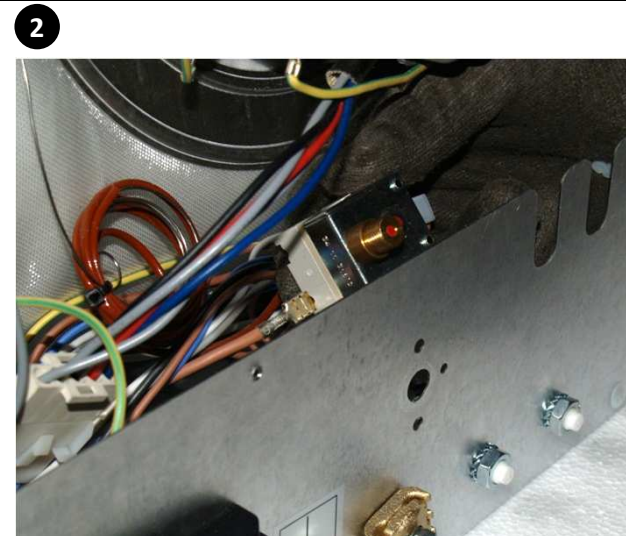
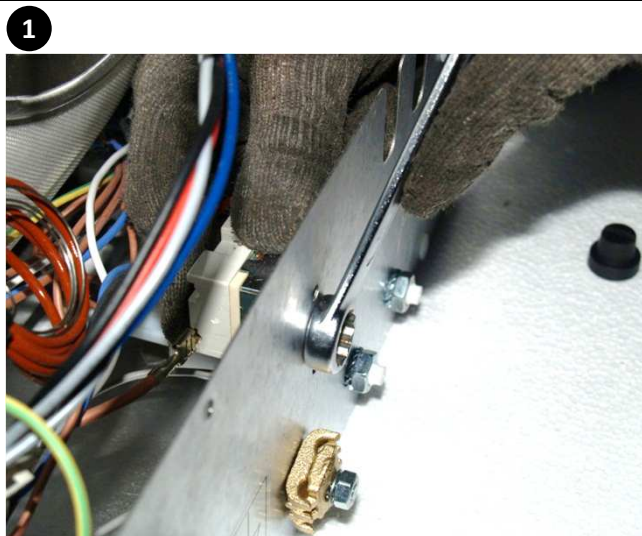

3.8 Water solenoid replacement

- Remove the two screws locking the water solenoid to the back support (1)
- Extract the water solenoid from the back support (2)
- Disconnect the two power supply wires and extract the 90°C male water fitting

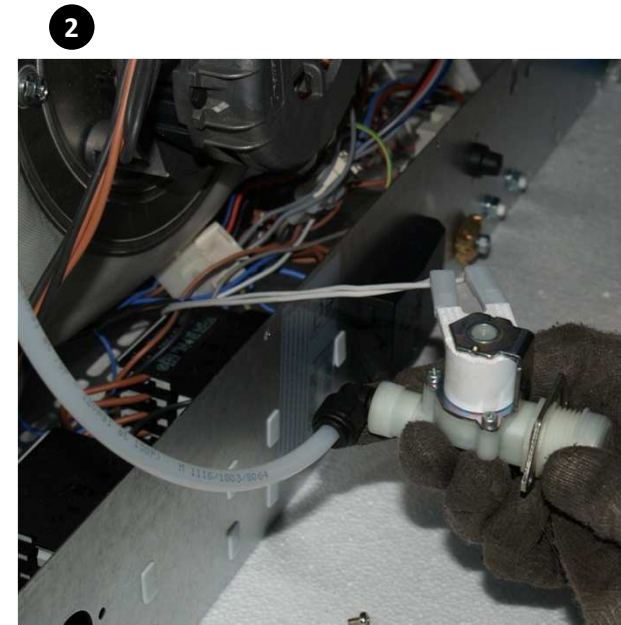
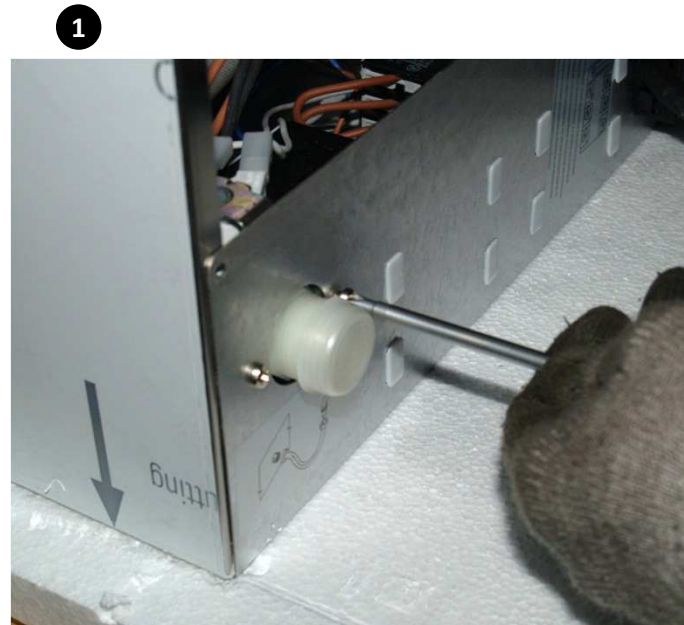

3.9 Cavity gasket replacement

- Pull to take off the old gasket (1)
- Carefully snap the new gasket respecting the right verse (2)
- To the corners, the gasket has to be snapped externally first then internally (3)
- Glue the two gasket strip to left or right side of the cavity room (4)

1



2



3



4

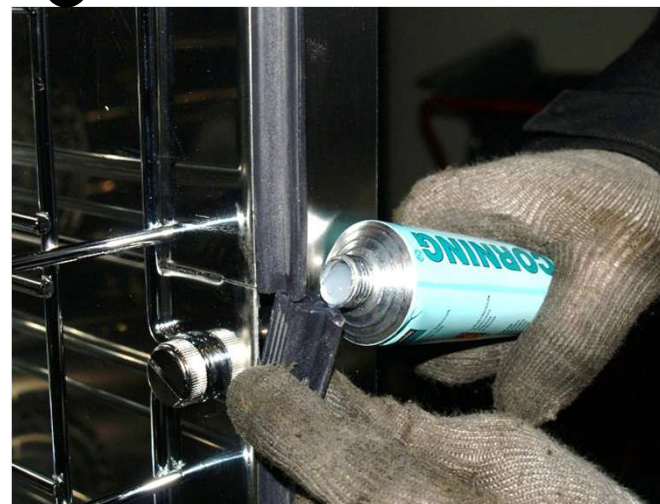

3.10 Hinges holder and door switch replacement

- Remove the mounting of screws holding the external case to the left, right and bottom side of the cavity room(1) (2) (3)
- Open the lateral side of the oven case (4)

1



2



3



4



3.10 Hinges holder and door switch replacement

- Remove the two screws locking the hinge holder
- Extract the hinge holder

5



6



3.10 Hinges holder and door switch replacement

- Remove the door switch locking nut (7)
- Extract the door switch (8)

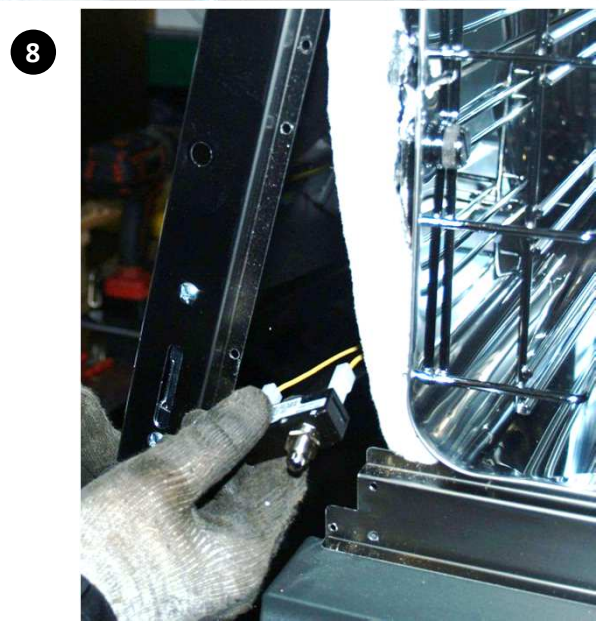

3.11 Fan replacement

- Disconnect the equipment from the electrical power supply.
- Remove the 4 screws holding the fan plate fan plate (1)
- Remove the brass nuts without touch the fan blades (2)
- Pull out the fan with the puller (3) (4).

1



2



3



4



3.12 Motor replacement

- Disconnect the equipment from the electrical power supply.
- Perform the extraction fan procedure.
- Disconnect the earth wire from the motor stator (1).
- Unplug the motor power supply 5 poles connector (2).
- Remove the 4 screws locking the motor to the proper support (3).
- Pull out the motor (4).

1



2

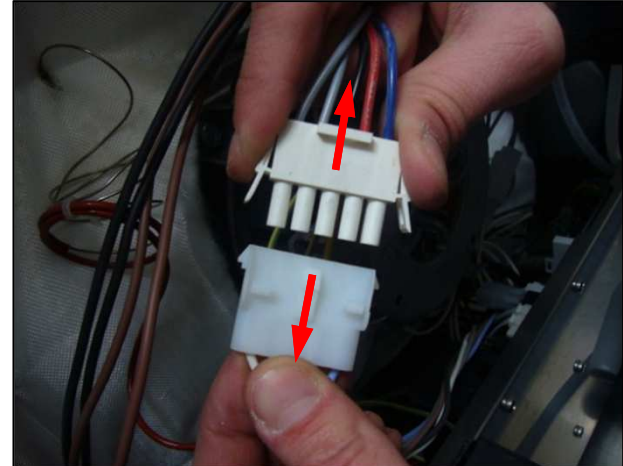

3

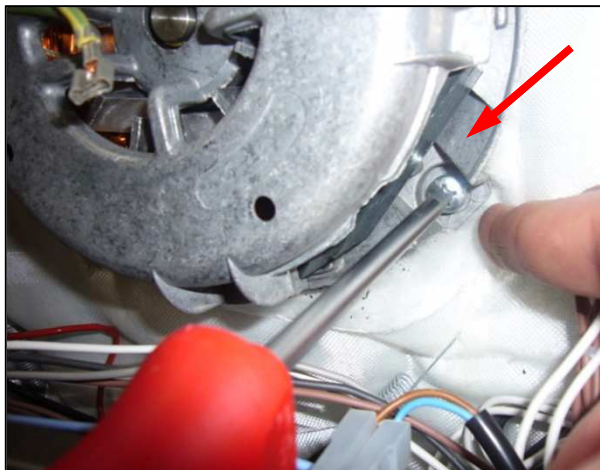

4

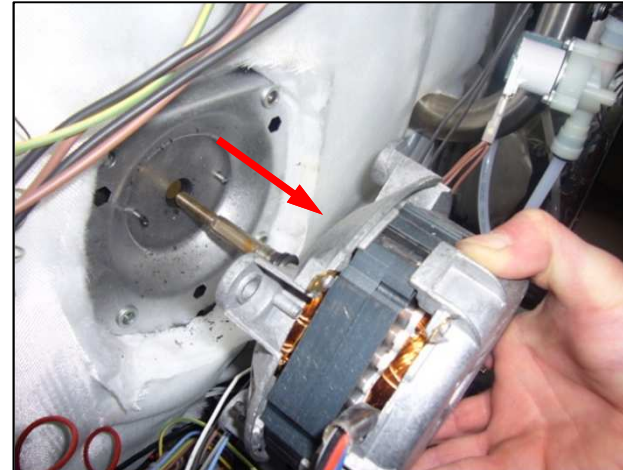

3.13 Heating element replacement

- Disconnect the equipment from the electrical power supply and leave it to cool.
- Perform the extraction fan procedure.
- Disconnect the earth and power supply wires from the heating element (1) (2)
- Remove the 5 screws holding the heating element to the cavity room (2).

1

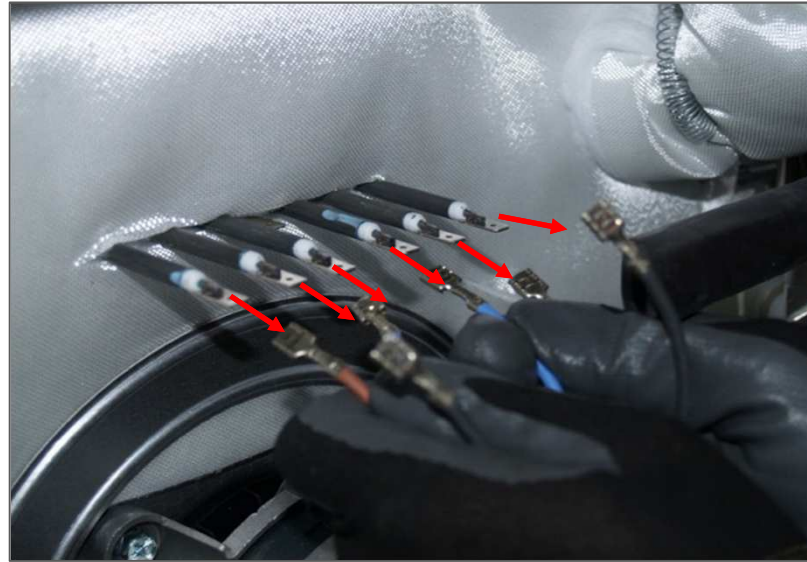

2

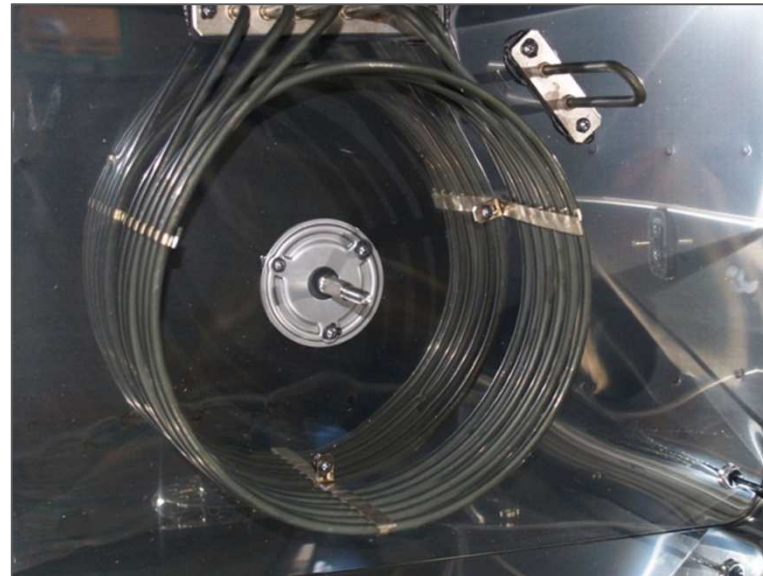

3.14 Cavity Probe replacement

- Disconnect the equipment from the electrical power supply.
- In the back of the oven disconnect the temperature probe connector (1)
- Remove the 2 screws fixing probe in the inner part of the chamber (2)
- Remove the probe from the outside of the chamber

1

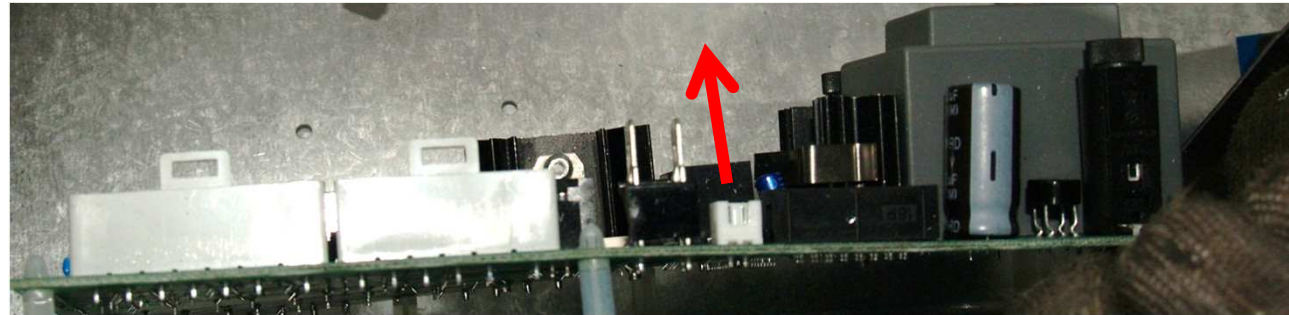

2

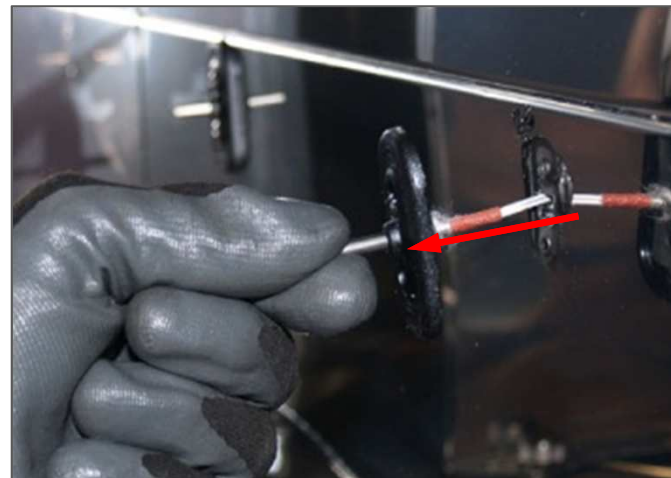

3



3.15 Useful Instruments

- 1. **ATR2040A0**: Service instruments case
- 2. **STR1385A0**: Water electric conductivity meter
- 3. **STR1290A0**: Digital multimeter
- 4. Water manometer
- 5. **STR1300A0**: Digital thermometer with K-type probe



3.15 Useful Instruments

7. CH1000A0: Snip tube cutter



8. CH1025A0 / CH1026A0: Unox J. Guest spanner



9. CH1030A0: Fan spanner



10. CH1015A0: Fan extractor





InfoNet

THE UNOX
LIMITED ACCESS AREA

FOR SERVICE CENTERS

DOWNLOAD THE USEFUL
DOCUMENTATION FOR
YOUR ACTIVITY!

AREN'T YOU ALREADY
REGISTERED?

www.unox.com